

# TR4110X-1

Categorie fornuis	110x60 cm
N. of cavities with energy label	2
Cavity heat source	Elektriciteit
Type kookplaat	Gas
Type primaire oven	Thermogeventileerd
Type secundaire oven	Geventileerd
Reinigingssysteem primaire oven	Vapor Clean reiniging
EAN-code	8017709295066
Energie-efficiëntieklasse	A
Energie-efficiëntieklasse, tweede oven	A



## Design



<b>Design</b>	Victoria	<b>Bedieningsknoppen</b>	Smeg Victoria
<b>Afwerking bedieningspaneel</b>	Inox	<b>Kleur bedieningsknoppen</b>	Inox
<b>Design</b>	Victoria	<b>Aantal bedieningsknoppen</b>	12
<b>Logo</b>	assembled 50's	<b>Kleur serigrafie</b>	Zwart
<b>Kleur</b>	Inox	<b>Display</b>	Elektronisch 5 toetsen
<b>Positie logo</b>	Upstand	<b>Deur</b>	Met kader
<b>Afwerking</b>	Glanzend	<b>Type glas</b>	Stopsol
<b>Upstand</b>	Ja	<b>Handgreep</b>	Smeg Victoria
<b>Kleur kookplaat</b>	Black enamel	<b>Kleur handgreep</b>	Geborsteld inox
<b>Type pottendragers</b>	Gietijzeren pottendragers	<b>Opbergruimte</b>	Opbergvak met lade
<b>Bediening</b>	Bedieningsknoppen	<b>Plint</b>	Antraciet

## Programma's / Functies

<b>Aantal kookfuncties</b>	5
<b>Traditionele bereidingsfuncties</b>	



Statisch



Geventileerd



Circulatie (ventilator + circulaire)



ECO



Geventileerde onderwarmte

### Overige functies



### Reinigingsfuncties



## Programma's / Functies secundaire oven

Aantal kookfuncties 5

Traditionele bereidingsfuncties, 2e oven



Circulatie (ventilator + circulaire)

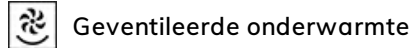

Vapor Clean reiniging



Reinigingsfunctie 2e oven

Overige functies 2e oven



## Programma's / Functies derde oven

Aantal functies derde oven

1

Licht



Grote vlakgrill



## Technische specificaties kookplaat



Totaal aantal kookzones 7

Linksvoor - Gas - 2URP (dual) - 4.20 kW

Linksvoor - Gas - AUX - 1.00 kW

Linksachter - Gas - RP - 2.90 kW

Middenvoor - Gas - RP - 2.90 kW

Middenachter - Gas - AUX - 1.00 kW

Rechtsvoor - Gas - SRD - 1.80 kW

Rechtsachter - Gas - SRD - 1.80 kW

Type gasbranders Standaard

Thermobeveiliging

Ja

Automatische vonkontsteking Ja

Branderdeksels

Mat zwart geëmailleerd

## Technische specificaties primaire oven



<b>Aantal lampen</b>	1	<b>Uitneembaar glas binnendeur</b>	Ja
<b>Aantal ventilatoren</b>	1	<b>Aantal ruiten ovendeur</b>	3
<b>Netto volume 1e oven</b>	61 l	<b>Aantal thermo-reflecterende ruiten</b>	1
<b>Bruto volume, oven 1</b>	70 l	<b>Veiligheidsthermostaat</b>	Ja
<b>Materiaal ovenruimte</b>	Ever Clean emaille	<b>Koelsysteem</b>	Mantelkoeling
<b>Aantal kookniveaus</b>	4	<b>Afmetingen bruikbare interne ovenruimte (hxbxd)</b>	316x460x412 mm
<b>Type ovenrekken</b>	Metalen zijsteunen	<b>Temperatuurregeling</b>	Elektro-mechanisch
<b>Type licht</b>	Halogeen	<b>Onderwarmte - vermogen</b>	1200 W
<b>Vermogen lamp</b>	40 W	<b>Bovenwarmte - vermogen</b>	1000 W
<b>Opties bereidingstijdprogrammering</b>	Begin en eind	<b>Grill - vermogen</b>	1700 W
<b>Opening deur</b>	Side opening	<b>Grote vlakgrill - vermogen</b>	2700 W
<b>Uitneembare ovendeur</b>	Ja	<b>Circulatie - vermogen</b>	2700 W
<b>Volledig glazen binnendeur</b>	Ja	<b>Grill type</b>	Elektrisch

## Opties primaire oven

<b>Timer</b>	Ja	<b>Minimum temperatuur</b>	50 °C
<b>Geluidssignaal einde kooktijd</b>	Ja	<b>Maximum temperatuur</b>	260 °C

## Technische specificaties secundaire oven



<b>Netto volume 2e oven</b>	61 l	<b>Aantal ruiten ovendeur</b>	3
<b>Bruto volume, oven 2</b>	70 l	<b>Aantal thermo-reflecterende ruiten</b>	1
<b>Materiaal ovenruimte</b>	Ever Clean emaille	<b>Veiligheidsthermostaat</b>	Ja
<b>Aantal kookniveaus</b>	4	<b>Koelsysteem</b>	Mantelkoeling
<b>Type ovenrekken</b>	Metalen zijsteunen	<b>Afmetingen bruikbare interne ovenruimte (hxbxd)</b>	316x444x425 mm
<b>Aantal lampen</b>	1	<b>Temperatuurregeling</b>	Elektro-mechanisch
<b>Type lamp</b>	Halogeen	<b>Onderwarmte - vermogen</b>	1200 W
<b>Vermogen lamp</b>	40 W	<b>Bovenwarmte - vermogen</b>	1000 W
<b>Opening deur</b>	Side opening	<b>Grill - vermogen</b>	1700 W
<b>Uitneembare ovendeur</b>	Ja		
<b>Volledig glazen binnendeur</b>	Ja		
<b>Uitneembaar glas binnendeur</b>	Ja		

Grote vlakgrill - vermogen	2700 W
Type grill	Elektrisch
Kantelbare grill	Ja

## Opties secundaire oven

Minimum temperatuur	50 °C	Maximum temperatuur	260 °C
---------------------	-------	---------------------	--------

## Technische specificaties derde oven



Netto volume, 3e oven	36 l	Uitneembaar glas binnendeur	Ja
Bruto volume, oven 3	41 l	Aantal ruiten ovendeur	3
Materiaal ovenruimte	Ever Clean emaille	Aantal thermo- reflecterende ruiten	1
Aantal kookniveaus	2	Veiligheidsthermostaat	Ja
Type ovenrekken	Metalen zijsteunen	Koelsysteem	Mantelkoeling
Aantal lampen	1	Afmetingen bruikbare interne ovenruimte (hxbxd)	169x440x443 mm
Type lamp	Gloeilamp	Temperatuurregeling	Elektro-mechanisch
Vermogen lamp	25 W	Grote vlakgrill - vermogen	2700 W
Opening deur	Neerwaarts	Type grill	Elektrisch
Uitneembare ovendeur	Ja	Kantelbare grill	Ja
Volledig glazen binnendeur	Ja		

## Opties derde oven

Minimum temperatuur	50 °C	Maximum temperatuur	260 °C
---------------------	-------	---------------------	--------

## Meegeleverde accessoires primaire oven en kookplaat



Gietijzeren wokring	1	Inzetrooster	1
Ovenrooster met stop	2	Telescopische geleiders, gedeeltelijk uitschuifbaar	1
Bakplaat (40 mm)	1		

## Meegeleverde accessoires secundaire oven



Ovenrooster met stop	2	Inzetrooster	1
Bakplaat (40 mm)	1	Telescopische geleiders, gedeeltelijk uitschuifbaar	1

## Meegeleverde accessoires derde oven

Ovenrooster met stop	1	Bakplaat (40 mm)	1
----------------------	---	------------------	---

## Elektrische aansluiting

Nominale aansluitwaarde	8400 W	Testkabel	Ja
Stroom	37 A	Type stroomkabel	Double and Three Phase
Spanning	220-240 V	Frequentie	50/60 Hz
Spanning 2 (V)	380-415 V	Connection box	5 polig
Electric cable	Installed, Single phase	Stekker	Nee

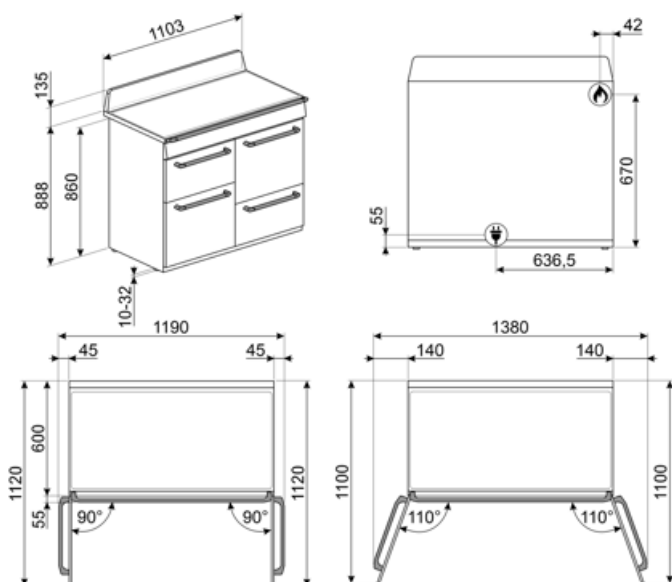

## Compatible Accessories

### AIRFRY



### BBQ

Dubbelzijdig



### BN640

Enamelled tray suitable for 45cm and 60cm ovens. Depth 540 mm. Perfect for cooking and roasting meat and fish in sauces. Also ideal for experimenting with lighter and crunchy side dishes



### GTP

Partially extractable telescopic guides (1 level), suitable for traditional ovens. Made in stainless steel, they guarantee stability and facilitate the smooth extraction of the trays.



### KIT1TR41N

Splashback black, 110cm ,suitable for TR4110 Victoria cookers



### KITH4110

Height extension kit (950mm), black, suitable for TR4110 cookers (945-965mm)



### PALPZ

Pizzapallet inox met ploibaar handvat, 315x325 mm



### SMOLD

Set van 7 siliconen vormen voor ijsjes, pralines, ijsblokjes of porties. -60°C tot 230°C.

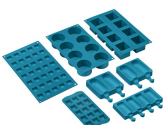

### AIRFRY2

Air fryer tray. Ideal for recreating traditional frying in the oven, but with fewer calories and less fat. It allows you to cook quickly and simply dishes such as French fries, fried vegetables and fish, ensuring perfect browning and crispiness.



### BN620-1

Enamelled tray suitable for 45 cm and 60 cm ovens. Depth 20 mm. Perfect for a wide range of savoury and sweet baking.



### BNP608T

Teflon bakplaat, 8mm diep



### GTT

Volledig uitschuifbare telescopische rails (1 niveau) voor traditionele ovens (SF-).



### KIT600TR4110

Cover strip for hob back side, suitable for TR4110 Victoria cookers



### KITP65TR41

Depth extension kit (650 mm), black, suitable for TR4110 cookers



### SFLK1

Child lock





























### WOKGHU

Gietijzeren wok steun



## Symbols glossary

 <p>Energy efficiency class A</p>	 <p>Heavy duty cast iron pan stands: for maximum stability and strength.</p>
 <p>Installation in column: Installation in column.</p>	 <p>Air cooling system: to ensure a safe surface temperatures.</p>
 <p>With the switch on this symbol, no heating is possible even if the thermostat is turned.</p>	 <p>Triple glazed doors: Number of glazed doors.</p>
 <p>Ever Clean Enamel: Ever Clean enamel is applied electrostatically, corner to corner and edge to edge to prevent cracking or cracks over time. It is a particular pyrolytic enamel, resistant to acids which, in addition to being pleasantly bright, promotes greater cleaning of the oven walls, thanks to its lower porosity. It is baked at over 850 °C and slowly polymerized at a scientifically determined rate to ensure uniform depth and strength. Ever Clean enamel creates an impeccable finish both on the inside of the oven and on the trays, making the surfaces of the oven incredibly easy to maintain over time as it reduces the adhesion of fat during cooking.</p>	 <p>Circogas: In gasovens verdeelt de ventilator de warmte snel en gelijkmatig over de ovenruimte, waardoor smaakoverdracht wordt vermeden bij het tegelijkertijd bereiden van een aantal verschillende gerechten. In elektrische ovens voltooit deze combinatie het koken van voedsel dat aan de oppervlakte klaar is, maar dat van binnen meer moet worden gekookt, zonder verder bruin te worden.</p>
 <p>Ventilator met bovenste en onderste elementen: De elementen in combinatie met de ventilator zijn bedoeld om een meer gelijkmatige warmte te bieden, een methode die vergelijkbaar is met conventioneel koken, dus voorverwarmen is vereist. Het meest geschikt voor items die langzaam koken vereisen.</p>	 <p>Alleen boven- en onder element: een traditionele kookmethode die het meest geschikt is voor losse items in het midden van de oven. de bovenkant van de oven zal altijd het heetst zijn. Ideaal voor gebraden vlees, fruitcake, brood etc.</p>
 <p>Circulaire: De combinatie van de ventilator en het ronde element eromheen zorgt voor een hete lucht kookmethode. Dit biedt vele voordelen, waaronder geen voorverwarmen als de kooktijd meer dan 20 minuten bedraagt, geen smaakoverdracht bij het gelijktijdig bereiden van verschillende soorten voedsel, minder energie en kortere kooktijden. Geschikt voor alle soorten voedsel.</p>	 <p>De combinatie van de grill, de ventilator en onderwarmte is interessant voor het bereiden van kleine hoeveelheden.</p>
 <p>Grill element: Using of grill gives excellent results when cooking meat of medium and small portions, especially when combined with a rotisserie (where possible). Also ideal for cooking sausages and bacon.</p>	 <p>Light</p>
 <p>All glass inner door: All glass inner door, a single flat surface which is simple to keep clean.</p>	 <p>The inner door glass: can be removed with a few quick movements for cleaning.</p>
 <p>Side lights: Two opposing side lights increase visibility inside the oven.</p>	 <p>The oven cavity has 2 different cooking levels.</p>

- 
-  The oven cavity has 4 different cooking levels.
  -  Electronic control: Allows you to maintain temperature inside the oven with the precision 2-3 ° C. This enables to cook meals that are very sensitive to temperature changes, such as cakes, souffles, puddings.
  -  Ultra rapid burners: Powerful ultra rapid burners offer up to 5kw of power.
  -  The capacity indicates the amount of usable space in the oven cavity in litres.
  -  Knobs control
  -  Telescopic rails: allow you to pull out the dish and check it without having to remove it from the oven entirely.
  -  Tilting grill: the tilting grill can be easily unhooked to move the heating element and clean the roof of the appliance in one simple step.
  -  Vapor Clean: a simple cleaning function using steam to loosen deposits in the oven cavity.
  -  The capacity indicates the amount of usable space in the oven cavity in litres.

## Benefit (TT)

---

### **Gas hob**

Gas provides permanent control of the heat source and the temperature change is immediate

Equipped with a thermocouple, the gas supply is cut off if the flame is extinguished for greater safety.

### **Vapor Clean**

By inserting water into a recess at the bottom of the cavity, steam is generated, which softens the residue and facilitates its removal

By inserting water into a recess at the bottom of the cavity, steam is generated, which softens the residue and facilitates its removal.

### **Buttons control**

Easy and intuitive timer setting with a simple buttons

### **Drawer storage compartment**

More space thanks to the lower drawer compartment, ideal for storing accessories or cooking utensils

### **True-convection**

The best cooking performances guaranteed by ventilated circular flow

Multiple fans and heating elements guarantee the perfect aerodynamic heat flow, allowing homogeneous and quicker cooking inside the cavity.

### **Multilevel cooking**

Several cooking levels allow maximum flexibility of use

### **Multilevel halogen light**

Internal halogen lighting on different levels guarantees excellent visibility

### **Removable inner glass**

Internal door glasses are easily removable for complete cleaning

### **Tangential cooling**

New cooling system with tangential fan and airflow from the door to the splashback

### **Telescopic guides**

Easy extraction and safe insertion of trays into the oven thanks to telescopic guides

### **Adjustable height**

Cooker top flushed with the working area thanks to adjustable feet

### **Isothermic Cavity**

The best cooking performance at the highest energy efficiency

### **BBQ (optional accessory)**

Barbecue cooking directly in the oven with the double-sided grill (BBQ optional accessory)

### **Pizza stone (optional accessory)**

Baking with refractory stone for soft and crispy pizza and yeast products (STONE optional accessory)

### **Cold door**

During any function, the external door glass is cold, avoiding any risk of burns

### **AirFry (AIRFRY optional accessory)**

Lighter and tastier food thanks to airfry basket (optional accessory)

### **Single turbine**

The oven has a fan equipped with a circular heating element allowing cooking with rotating heat