

# TR4110X-1

Cooker size	110x60 cm
N.º de cavidades com rótulo energético	2
Fonte de calor da cavidade	ELECTRICITY
Hob type	Gas
Tipo de forno principal	Thermo-ventilated
Type of second oven	Fan assisted
Sistema de limpeza no forno principal	Vapor Clean
EAN code	8017709295066
Energy efficiency class	A
Energy efficiency class, second cavity	A



## Aesthetics



<b>Aesthetic</b>	Victoria	<b>Control knobs</b>	Smeg Victoria
<b>Design</b>	Victoria	<b>Controls colour</b>	Stainless steel
<b>Colour</b>	Stainless steel	<b>No. of controls</b>	12
<b>Acabamento</b>	Brilhante	<b>Cor da serigrafia</b>	Serigrafia em preto
<b>Command panel finish</b>	Stainless steel	<b>Display</b>	electronic 5 buttons
<b>Logo</b>	Logotipo Anni 50	<b>Door</b>	With frame
<b>Posição do logotipo</b>	Logotipo na zona da placa	<b>Glass type</b>	Stopsol
<b>Upstand</b>	Yes	<b>Handle</b>	Smeg Victoria
<b>Cor da placa</b>	Esmalte preto	<b>Handle Colour</b>	Brushed stainless steel
<b>Type of pan stands</b>	Cast Iron	<b>Storage compartment</b>	Drawer
<b>Type of control setting</b>	Control knobs	<b>Plinth</b>	Anthracite

## Programs / Functions

No. of cooking functions 5

Traditional cooking functions



Static

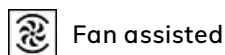

Fan assisted

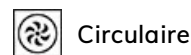

Circulaire



Eco



Fan assisted bottom

Other functions



Defrost

Recipes No

## Cleaning functions

 Vapor clean

## Programs / Functions Auxiliary Oven

Funções de cozedura cavidade 2 5

Funções tradicionais de cozimento, cavidade 2

 Static

 Fan assisted

 Circulaire

 Eco



Parte inferior assistida por ventilador

Vapor Clean



Funções de limpeza cavidade 2

Outras funções cavidade 2

 Defrost

## Programs / Functions Third Oven

No. of functions third oven

1

Oven light



Half grill

No

Full grill



## Hob technical features

**UR**

Total no. of cook zones 7

Left - Gas - 2UR (dual) - 4.20 kW

Front left - Gas - AUX - 1.00 kW

Rear left - Gas - Rapid - 2.90 kW

Front centre - Gas - Rapid - 2.90 kW

Rear centre - Gas - AUX - 1.00 kW

Front right - Gas - Semi Rapid - 1.80 kW

Rear right - Gas - Semi Rapid - 1.80 kW

Type of gas burners Standard

Gas safety valves Yes

Automatic electronic ignition Yes

Burner caps

Matt black enamelled

## Main Oven Technical Features



<b>No. of lights</b>	1
<b>Fan number</b>	1
<b>Net volume of the cavity</b>	61 l
<b>Gross volume, 1st cavity</b>	70 l
<b>Cavity material</b>	Ever Clean enamel
<b>No. of shelves</b>	4
<b>Type of shelves</b>	Metal racks
<b>Roof Liner</b>	No
<b>Light type</b>	Halogen
<b>Light Power</b>	40 W
<b>Cooking time setting</b>	Start and Stop
<b>Door opening</b>	Side opening
<b>Removable door</b>	Yes
<b>Full glass inner door</b>	Yes

<b>Removable inner door</b>	Yes
<b>Total no. of door glasses</b>	3
<b>No. of thermo-reflective door glasses</b>	1
<b>Safety Thermostat</b>	Yes
<b>Cooling system</b>	Tangential
<b>Usable cavity space dimensions (HxWxD)</b>	316x460x412 mm
<b>Temperature control</b>	Electro-mechanical
<b>Lower heating element power</b>	1200 W
<b>Upper heating element - Power</b>	1000 W
<b>Grill element</b>	1700 W
<b>Large grill - Power</b>	2700 W
<b>Circular heating element - Power</b>	2700 W
<b>Grill type</b>	Electric
<b>Tilting grill</b>	No

## Options Main Oven

<b>Timer</b>	Yes
<b>End of cooking acoustic alarm</b>	Yes

<b>Minimum Temperature</b>	50 °C
<b>Maximum temperature</b>	260 °C

## Second Oven Technical Features



<b>Net volume of the second cavity</b>	61 l
<b>Gross volume, 2nd cavity</b>	70 l
<b>Cavity material</b>	Ever Clean enamel
<b>No. of shelves</b>	4
<b>Type of shelves</b>	Metal racks
<b>Roof Liner</b>	No
<b>No. of lights</b>	1
<b>Light type</b>	Halogen
<b>Light Power</b>	40 W
<b>Cooking time setting</b>	No
<b>Door opening</b>	Side opening
<b>Removable door</b>	Yes
<b>Full glass inner door</b>	Yes

<b>Removable inner door</b>	Yes
<b>No. total door glasses</b>	3
<b>No. thermo-reflective door glasses</b>	1
<b>Safety Thermostat</b>	Yes
<b>Cooling system</b>	Tangential
<b>Usable cavity space dimensions (HxWxD)</b>	316x444x425 mm
<b>Temperature control</b>	Electro-mechanical
<b>Lower heating element - power</b>	1200 W
<b>Upper heating element - Power</b>	1000 W
<b>Grill element - power</b>	1700 W
<b>Large grill - Power</b>	2700 W
<b>Grill type</b>	Electric
<b>Tilting grill</b>	Yes

## Options Auxiliary Oven

Timer	No	Minimum Temperature	50 °C
End of cooking acoustic alarm	No	Maximum temperature	260 °C

## Third Oven Technical Features



Net volume, 3rd cavity	36 l	Full glass inner door	Yes
Gross volume, 3rd cavity	41 l	Removable inner door	Yes
Cavity material	Ever Clean enamel	No. total door glasses	3
No. of shelves	2	No. of thermo-reflective door glasses	1
Type of shelves	Metal racks	Safety Thermostat	Yes
Roof Liner	No	Cooling system	Tangential
No. of lights	1	Usable cavity space dimensions (HxWxD)	169x440x443 mm
Light type	Incandescent	Temperature control	Electro-mechanical
Light Power	25 W	Large grill - Power	2700 W
Door opening	Flap down	Grill type	Electric
Removable door	Yes	Tilting grill	Yes

## Options Third Oven

Timer	No	Minimum Temperature	50 °C
End of cooking acoustic alarm	No	Maximum temperature	260 °C

## Accessories included for Main Oven & Hob



Cast iron wok support	1	Grill mesh	1
Rack com batente traseiro e lateral	2	Telescopic Guide rails, partial Extraction	1
40mm deep tray	1		

## Accessories included for Secondary Oven



Rack com batente traseiro e lateral	2	Grill mesh	1
40mm deep tray	1	Telescopic Guide rails, partial Extraction	1

## Accessories included for Third Oven

Rack com batente traseiro e lateral	1	40mm deep tray	1
-------------------------------------	---	----------------	---

## Electrical Connection

<b>Plug</b>	No	<b>Electric cable</b>	Installed, Single phase
<b>Electrical connection rating</b>	8400 W	<b>cabo de alimentação de teste</b>	Sim
<b>Current</b>	37 A	<b>Type of electric cable</b>	Double and Three Phase
<b>Voltage</b>	220-240 V	<b>Frequency</b>	50/60 Hz
<b>Voltage 2 (V)</b>	380-415 V	<b>Bloco de terminais</b>	5 polos

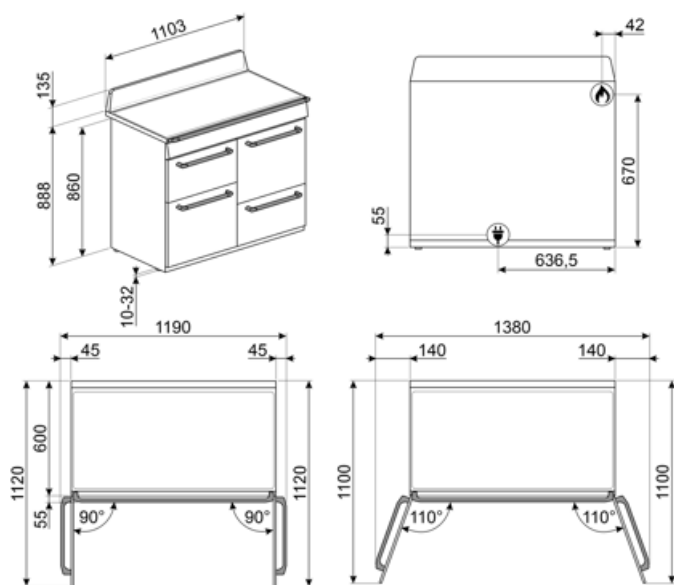

## Compatible Accessories

### AIRFRY

Air fryer rack AIRFRY . Ideal for recreating traditional frying in the oven, but with fewer calories and less fat. It allows you to cook quickly and simply dishes such as French fries, fried vegetables and fish, ensuring perfect browning and crispiness.



### BGTR4110

Placa para grelhar de ferro fundido adequada para fogões Victoria TR4110



### BN640

Tabuleiro esmaltado, 40mm de profundidade

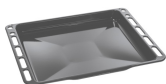

### GTP

\*\* Guias telescópicas parcialmente extraíveis (1 nível)\*\* Extração: 300 mm  
Material: Aço inoxidável AISI 430 polido



### KIT1TR41N

Painel anti-salpicos 110x75 cm adequado para fogões TR4110 Victoria, preto



### KITH4110

Kit extensão de altura (950 mm), adequado para fogões TR4110



### PALPZ

Pá para pizza com alça dobrável largura: 315mm comprimento : 325mm



### SMOLD

Conjunto de 7 moldes de silicone para sorvetes, gelados, pralinés, cubos de gelo ou para porção de alimentos. Utilizável de -60°C a +230°C

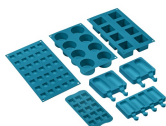

### BBQ

Double sided plate BBQ. Suitable for recreating succulent and crispy dishes in the oven with the typical taste of grilled cooking. The ribbed side is particularly suitable for meats and cheeses. The smooth side for fish, seafood and vegetables.



### BN620-1

Tabuleiro esmaltado, 20mm de profundidade



### BNP608T

Bandeja revestida de teflon, 8mm de profundidade, a ser colocada na grade



### GTT

\*\* Guias telescópicas totalmente extraíveis (1 nível)\*\* Extração: 433 mm  
Material: Aço inoxidável AISI 430 polido



### KIT600TR4110

Tira de cobertura para placa traseira, adequado para fogões Victoria TR4110



### KITP65TR41

Kit extensão de profundidade (650 mm), adequado para fogões TR4110



### SFLK1

Bloqueio para crianças



### TPKTR

Placa grelhadora teppanyaki para fogões TR4110























**WOKGHU**

Suporte de ferro fundido para WOK



## Symbols glossary

 <p>Suportes de ferro fundido para serviço pesado: para máxima estabilidade e resistência.</p>	 <p>R: Desempenho de secagem do produto, medido de A++ a D/G, dependendo da família de produtos</p>
 <p>Instalação em coluna: Instalação em coluna</p>	 <p>Controle dos botões</p>
 <p>Sistema de arrefecimento a ar: para garantir temperaturas de superfície seguras.</p>	 <p>Com o interruptor neste símbolo, nenhum aquecimento é possível mesmo se o termostato estiver ligado.</p>
 <p>Portas envidraçadas triplas: Número de portas envidraçadas.</p>	 <p>Interior esmaltado: O interior em esmalte de todos os fornos Smeg tem um revestimento antiácido especial que ajuda a manter o interior limpo, reduzindo a quantidade de gordura de cozimento aderente a ele.</p>
 <p>Circogas: Em fornos a gás, o ventilador distribui o calor de forma rápida e uniforme por toda a cavidade do forno, evitando a transferência de sabor ao cozinhar vários pratos diferentes ao mesmo tempo. Em fornos elétricos, esta combinação completa o cozimento mais rapidamente de alimentos que estão prontos na superfície, mas que exigem mais cozimento no interior, sem mais escurecimento.</p>	 <p>Ventilador com elementos superiores e inferiores: Os elementos combinados com o ventilador visam fornecer calor mais uniforme, um método semelhante ao cozimento convencional, de modo que o pré-aquecimento é necessário. Mais adequado para itens que exigem métodos de cozimento lento.</p>
 <p>Somente elementos superior e inferior: um método de cozimento tradicional mais adequado para itens individuais localizados no centro do forno. A parte superior do forno será sempre mais quente. Ideal para assados, bolos de frutas, pão, etc.</p>	 <p>Circulaire: A combinação do ventilador e do elemento circular em torno dele dá um método de cozimento de ar quente. Isso oferece muitos benefícios, incluindo nenhum pré-aquecimento se o tempo de cozimento for superior a 20 minutos, nenhuma transferência de sabor ao cozinhar alimentos diferentes ao mesmo tempo, menos energia e tempos de cozimento mais curtos. Bom para todos os tipos de alimentos.</p>
 <p>ECO: A combinação da grelha, ventilador e elemento inferior é particularmente adequada para cozinhar pequenas quantidades de alimentos.</p>	 <p>Elemento de grelha O uso de grelha dá excelentes resultados ao cozinhar carne de porções médias e pequenas, especialmente quando combinada com uma rotisseria (sempre que possível). Também é ideal para cozinhar salsichas e bacon.</p>
 <p>Luz</p>	 <p>Toda a porta interna de vidro: Toda a porta interna de vidro, uma única superfície plana que é simples de manter limpa.</p>
 <p>O vidro interior da porta: pode ser removido com alguns movimentos rápidos para limpeza.</p>	 <p>Luzes laterais: Duas luzes laterais opostas aumentam a visibilidade dentro do forno.</p>
 <p>O compartimento do forno tem 2 níveis de cozimento diferentes.</p>	 <p>O compartimento do forno tem 4 níveis de cozimento diferentes.</p>





Trilhos telescópicos: permitem puxar o prato e verificá-lo sem ter que removê-lo completamente do forno.



Grelha basculante: a grelha basculante pode ser facilmente desengatada para mover o elemento de aquecimento e limpar o tejadilho do aparelho em um simples passo.



Limpeza a Vapor: uma função de limpeza simples que utiliza vapor para afrouxar os depósitos no compartimento do forno.



A capacidade indica a quantidade de espaço útil no compartimento do forno em litros.



Comando eletrônico. Permite manter a temperatura no interior do forno com a precisão de 2-3 ° C. Isso permite cozinhar refeições que são muito sensíveis a mudanças de temperatura, como por ex. bolos, suflês, pudins.



Queimadores ultrarrápidos: Queimadores ultrarrápidos potentes oferecem até 5kw de potência.



A capacidade indica a quantidade de espaço útil no compartimento do forno em litros.

## Benefit (TT)

---

### **Gas hob**

Gas provides permanent control of the heat source and the temperature change is immediate

Equipped with a thermocouple, the gas supply is cut off if the flame is extinguished for greater safety.

### **Vapor Clean**

By inserting water into a recess at the bottom of the cavity, steam is generated, which softens the residue and facilitates its removal

By inserting water into a recess at the bottom of the cavity, steam is generated, which softens the residue and facilitates its removal.

### **Buttons control**

Easy and intuitive timer setting with a simple buttons

### **Drawer storage compartment**

More space thanks to the lower drawer compartment, ideal for storing accessories or cooking utensils

### **True-convection**

The best cooking performances guaranteed by ventilated circular flow

Multiple fans and heating elements guarantee the perfect aerodynamic heat flow, allowing homogeneous and quicker cooking inside the cavity.

### **Multilevel cooking**

Several cooking levels allow maximum flexibility of use

### **Multilevel halogen light**

Internal halogen lighting on different levels guarantees excellent visibility

### **Removable inner glass**

Internal door glasses are easily removable for complete cleaning

### **Tangential cooling**

New cooling system with tangential fan and airflow from the door to the splashback

### **Telescopic guides**

Easy extraction and safe insertion of trays into the oven thanks to telescopic guides

### **BBQ (optional accessory)**

Barbeque cooking directly in the oven with the double-sided grill (BBQ optional accessory)

**Pizza stone (optional accessory)**

Baking with refractory stone for soft and crispy pizza and yeast products (STONE optional accessory)

**Isothermic Cavity**

The best cooking performance at the highest energy efficiency

**Adjustable height**

Cooker top flushed with the working area thanks to adjustable feet

**Cold door**

During any function, the external door glass is cold, avoiding any risk of burns

**AirFry (AIRFRY optional accessory)**

Lighter and tastier food thanks to airfry basket (optional accessory)

**Single turbine**

The oven has a fan equipped with a circular heating element allowing cooking with rotating heat