

# TR62BL

Cooker size	60x60 cm
N. of cavities with energy label	2
Cavity heat source	ELECTRICITY
Hob type	Gas
Type of main oven	Thermo-ventilated
Type of second oven	Static
Cleaning system main oven	Ever Clean enamel
EAN code	8017709210625
Energy efficiency class	A
Energy efficiency class, second cavity	A



## Aesthetics



<b>Design</b>	Victoria	<b>Type of control knobs</b>	Smeg Victoria
<b>Command panel finish</b>	Enamelled metal	<b>Controls colour</b>	Stainless steel
<b>Aesthetic</b>	Victoria	<b>No. of controls</b>	6
<b>Logo</b>	assembled 50's	<b>Serigraphy colour</b>	Silver
<b>Colour</b>	Black	<b>Display name</b>	Electronic 5 buttons
<b>Logo position</b>	Upstand	<b>Door</b>	With frame
<b>Finishing</b>	Glossy	<b>Glass type</b>	Black
<b>Upstand</b>	Yes	<b>Handle</b>	Smeg Victoria
<b>Hob colour</b>	Black enamel	<b>Handle Colour</b>	Brushed stainless steel
<b>Type of pan stands</b>	Cast Iron	<b>Plinth</b>	Anthracite
<b>Type of control setting hob</b>	Control knobs		

## Programs / Functions main oven

No. of cooking functions	4
Traditional cooking functions	



Static



Small grill



Large grill



Base

## Hob technical features

<b>UR</b>			
<b>Total no. of cook zones</b> 4			
Front left - Gas - 2UR (dual) - 4.20 kW			
Rear left - Gas - Semi Rapid - 1.80 kW			
Rear right - Gas - Semi Rapid - 1.80 kW			
Front right - Gas - AUX - 1.00 kW			
<b>Type of gas burners</b>	Standard	<b>Gas safety valves</b>	Yes
<b>Automatic electronic ignition</b>	Yes	<b>Burner caps</b>	Matt black enamelled

## Main Oven Technical Features



<b>No. of lights</b>	1	<b>Full glass inner door</b>	Yes
<b>Net volume of the cavity</b>	61 l	<b>Removable inner door</b>	Yes
<b>Gross volume, 1st cavity</b>	70 l	<b>Total no. of door glasses</b>	2
<b>Cavity material</b>	Ever Clean enamel	<b>No. of thermo-reflective door glasses</b>	1
<b>No. of shelves</b>	4	<b>Safety Thermostat</b>	Yes
<b>Type of shelves</b>	Metal racks	<b>Cooling system</b>	Tangential
<b>Light type</b>	Halogen	<b>Usable cavity space dimensions (HxWxD)</b>	316x460x412 mm
<b>Light Power</b>	40 W	<b>Temperature control</b>	Electro-mechanical
<b>Cooking time setting</b>	Start and Stop	<b>Circular heating element - Power</b>	2700 W
<b>Removable door</b>	Yes		

## Options Main Oven

<b>Timer</b>	Yes	<b>Minimum Temperature</b>	50 °C
<b>End of cooking acoustic alarm</b>	Yes	<b>Maximum temperature</b>	245 °C

## Second Oven Technical Features



<b>Net volume of the second cavity</b>	35 l	<b>No. thermo-reflective door glasses</b>	1
<b>Gross volume, 2nd cavity</b>	41 l	<b>Safety Thermostat</b>	Yes
<b>Cavity material</b>	Ever Clean enamel	<b>Cooling system</b>	Tangential
<b>No. of shelves</b>	2	<b>Usable cavity space dimensions (HxWxD)</b>	169x440x443 mm
<b>Type of shelves</b>	Metal racks	<b>Temperature control</b>	Electro-mechanical
<b>No. of lights</b>	1	<b>Lower heating element - power</b>	1200 W
<b>Light type</b>	Halogen	<b>Upper heating element - Power</b>	1000 W
<b>Light Power</b>	40 W	<b>Grill element - power</b>	1700 W
<b>Removable door</b>	Yes	<b>Large grill - Power</b>	2700 W
<b>Full glass inner door</b>	Yes	<b>Grill type</b>	Electric
<b>Removable inner door</b>	Yes		

No. total door glasses	2	Tilting grill	Yes
------------------------	---	---------------	-----

## Options Auxiliary Oven

Minimum Temperature	50 °C	Maximum temperature	245 °C
---------------------	-------	---------------------	--------

## Accessories included for Main Oven & Hob



Moka stand	1	Grill mesh	1
Rack with back and side stop	2	Telescopic Guide rails, partial Extraction	1
40mm deep tray	1		

## Accessories included for Secondary Oven

Rack with back and side stop	1	Grill mesh	1
40mm deep tray	1		

## Electrical Connection

Electrical connection rating	5500 W	Power supply cable length	120 cm
Current	24 A	Additional connection modalities	Double and Three Phase
Voltage	220-240 V	Frequency	50/60 Hz
Voltage 2 (V)	380-415 V	Terminal block	5 poles
Electric cable	Installed, Single phase	Plug	Not present

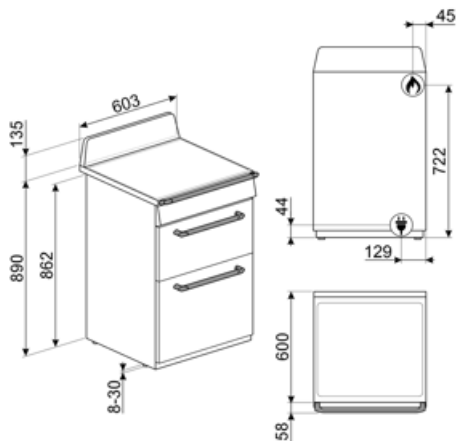

## Compatible Accessories

### AIRFRY

Air fryer rack AIRFRY. Ideal for recreating traditional frying in the oven, but with fewer calories and less fat. It allows you to cook quickly and simply dishes such as French fries, fried vegetables and fish, ensuring perfect browning and crispiness.



### BBQ

Double sided plate BBQ. Suitable for recreating succulent and crispy dishes in the oven with the typical taste of grilled cooking. The ribbed side is particularly suitable for meats and cheeses. The smooth side for fish, seafood and vegetables.



### BN640

Enamelled tray suitable for 45cm and 60cm ovens. Depth 540 mm. Perfect for cooking and roasting meat and fish in sauces. Also ideal for experimenting with lighter and crunchy side dishes



### GTP

Partially extractable telescopic guides (1 level), suitable for traditional ovens. Made in stainless steel, they guarantee stability and facilitate the smooth extraction of the trays.



### KIT1TR6N

Splashback black, 60cm ,suitable for TR62 Victoria cookers



### PALPZ

Pizza shovel with folding handle. Dimensions L31.5 x H32.5 cm. Easy and convenient to use and store. Perfect for serving pizza, bread and savory pastries in a safe and professional way.



### SMOLD

Set of 7 silicone moulds for ice creams, ice lollies, pralines, ice cubes or to portion food. Usable from -60°C to +230°C

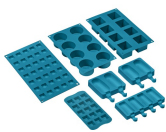

### AIRFRY2

Air fryer tray. Ideal for recreating traditional frying in the oven, but with fewer calories and less fat. It allows you to cook quickly and simply dishes such as French fries, fried vegetables and fish, ensuring perfect browning and crispiness.



### BN620-1

Enamelled tray suitable for 45 cm and 60 cm ovens. Depth 20 mm. Perfect for a wide range of savoury and sweet baking.



### BNP608T

Teflon-coated tray, 8 mm depth, to be placed on the grid



### GTT

Totally extractable telescopic guides (1 level), suitable for traditional ovens. Made in stainless steel, they guarantee stability and facilitate the smooth extraction of the trays.



### KITH60

Height extension kit (950 mm), black, suitable for TR60 cookers

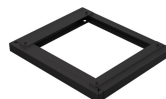

### SFLK1

Child lock

























### STONE

Rectangular refractory stone Ideal for cooking pizzas with the same results as a typical wood-fired oven. Can also be used for baking bread, focaccias and other recipes such as pies, flans or biscuits Dimensions:L42 x H1,8 x P37,5 cm.



## Symbols glossary

	Heavy duty cast iron pan stands: for maximum stability and strength.		Energy efficiency class A
	Installation in column: Installation in column.		Knobs control
	Air cooling system: to ensure a safe surface temperatures.		Double glazed doors: Number of glazed doors.
	Ever Clean Enamel: Ever Clean enamel is applied electrostatically, corner to corner and edge to edge to prevent cracking or cracks over time. It is a particular pyrolytic enamel, resistant to acids which, in addition to being pleasantly bright, promotes greater cleaning of the oven walls, thanks to its lower porosity. It is baked at over 850 °C and slowly polymerized at a scientifically determined rate to ensure uniform depth and strength. Ever Clean enamel creates an impeccable finish both on the inside of the oven and on the trays, making the surfaces of the oven incredibly easy to maintain over time as it reduces the adhesion of fat during cooking.		Static: Traditional cooking suitable for the preparation of one dish at a time. The fan is not active and the heat comes from below and from above at the same time. Static cooking is slower and more delicate, ideal in order to get well cooked and dry dishes even inside. Ideal for cooking all types of roasts, fatty meats, bread, filled cakes.
	Base: the heat comes only from the bottom of the cavity. The fan is not active. Ideal for sweet and savory pies, cobblers and pizzas. Designed to complete cooking and make food more crunchy. This symbol in gas ovens indicates the gas burner.		Circulaire: it is the perfect function for cooking all types of dishes in a more delicate way. The heat comes from the back of the oven and is distributed quickly and evenly. The fan is active. It is also ideal for cooking on multiple levels without mixing smells and flavors.
	Grill: Very intense heat coming only from above from a double heating element. The fan is not active. Provides excellent grilling and gratinating results. Used at the end of cooking, it gives a uniform browning to dishes.		Half grill: For rapid cooking and browning of foods. Best results can be obtained by using the top shelf for small items, the lower shelves for larger ones, such as chops or sausages. For half grill heat is generated only at the centre of the element, so is ideal for smaller quantities.
	Light		All glass inner door: All glass inner door, a single flat surface which is simple to keep clean.
	The inner door glass: can be removed with a few quick movements for cleaning.		Side lights: Two opposing side lights increase visibility inside the oven.
	The oven cavity has 2 different cooking levels.		The oven cavity has 4 different cooking levels.
	Telescopic rails: allow you to pull out the dish and check it without having to remove it from the oven entirely.		Electronic control: Allows you to maintain temperature inside the oven with the precision 2-3 ° C. This enables to cook meals that are very sensitive to temperature changes, such as cakes, souffles, puddings.
	Tilting grill: the tilting grill can be easily unhooked to move the heating element and clean the roof of the appliance in one simple step.		Ultra rapid burners: Powerful ultra rapid burners offer up to 5kw of power.



The capacity indicates the amount of usable space in the oven cavity in litres.



The capacity indicates the amount of usable space in the oven cavity in litres.

## Benefit (TT)

---

### **Gas hob**

Gas provides permanent control of the heat source and the temperature change is immediate  
Equipped with a thermocouple, the gas supply is cut off if the flame is extinguished for greater safety.

### **Ever Clean Enamel**

Easy oven cleaning thanks to special pyrolytic enamel

### **Buttons control**

Easy and intuitive timer setting with a simple buttons

### **True-convection**

The best cooking performances guaranteed by ventilated circular flow  
Multiple fans and heating elements guarantee the perfect aerodynamic heat flow, allowing homogeneous and quicker cooking inside the cavity.

### **Multilevel cooking**

Several cooking levels allow maximum flexibility of use

### **Multilevel halogen light**

Internal halogen lighting on different levels guarantees excellent visibility

### **Removable inner glass**

Internal door glasses are easily removable for complete cleaning

### **Tangential cooling**

New cooling system with tangential fan and airflow from the door to the splashback

### **Telescopic guides**

Easy extraction and safe insertion of trays into the oven thanks to telescopic guides

### **Adjustable height**

Cooker top flushed with the working area thanks to adjustable feet

### **AirFry (AIRFRY optional accessory)**

Lighter and tastier food thanks to airfry basket (optional accessory)

### **Cold door**

During any function, the external door glass is cold, avoiding any risk of burns

---

**Pizza stone (optional accessory)**

Baking with refractory stone for soft and crispy pizza and yeast products (STONE optional accessory)

**BBQ (optional accessory)**

Barbecue cooking directly in the oven with the double-sided grill (BBQ optional accessory)

**Isothermic Cavity**

The best cooking performance at the highest energy efficiency