

TR90DGM9

Cooker size	90x60 cm
N. of cavities with energy label	1
Cavity heat source	ELECTRICITY
Hob type	Gas
Type of main oven	Thermo-ventilated
Cleaning system main oven	Catalytic
EAN code	8017709268435
Energy efficiency class	A



Aesthetics











Aesthetic	Victoria	Type of control setting hob	Control knobs
Series	Divina Cucina	Type of control knobs	Smeg Victoria
Design	Victoria	Controls colour	Stainless steel
Colour	Decorated / Special	No. of controls	8
Finishing	Glossy	Serigraphy colour	Silver
Command panel finish	Enamelled metal	Display name	Electronic 5 buttons
Decoration / Special colour	Maiolica	Door	With frame
Collaborations	Smeg & Dolce&Gabbana	Glass type	Black
Logo	assembled 50's	Handle	Smeg Victoria
Logo position	Upstand+ Command panel	Handle Colour	Polished chrome
Upstand	Yes	Storage compartment	Drawer
Hob colour	Black enamel	Feet color	none
Type of pan stands	Cast Iron	Plinth	Anthracite

Programs / Functions main oven

No. of cooking functions	9
--------------------------	---

Traditional cooking functions

 Static	 Fan assisted	 Circulaire
 Eco	 Large grill	 Fan grill (large)
 Base	 Fan assisted base	 Rotisserie

Other functions

 Defrost by time
--











Cleaning functions

Catalytic	 Vapor clean
-----------	---

Hob technical features

			
Total no. of cook zones	5		
Front left - Gas - Rapid	- 2.90 kW		
Rear left - Gas - Semi Rapid	- 1.80 kW		
Central - Gas - 2UR (dual)	- 5.00 kW		
Rear right - Gas - Semi Rapid	- 1.80 kW		
Front right - Gas - AUX	- 1.00 kW		
Type of gas burners	Standard	Gas safety valves	Yes
Automatic electronic ignition	Yes	Burner caps	Matt black enamelled

Main Oven Technical Features

									
No. of lights	2	Removable inner door	Yes						
Fan number	2	Total no. of door glasses	3						
Net volume of the cavity	115 l	No. of thermo-reflective door glasses	2						
Gross volume, 1st cavity	129 l	Safety Thermostat	Yes						
Cavity material	Ever Clean enamel	Cooling system	Tangential						
No. of shelves	5	Usable cavity space dimensions (HxWxD)	371x724x418 mm						
Type of shelves	Metal racks	Temperature control	Electro-mechanical						
Light type	Halogen	Lower heating element power	1700 W						
Light Power	40 W	Upper heating element - Power	1200 W						
Cooking time setting	Start and Stop	Grill element	1700 W						
Light when oven door is open	Yes	Large grill - Power	2900 W						
Door opening	Flap down								
Removable door	Yes								
Full glass inner door	Yes								

Circular heating element	2 x 1550 W
- Power	
Grill type	Electric
Soft Close system	Yes

Options Main Oven

Timer	Yes	Minimum Temperature	50 °C
End of cooking acoustic alarm	Yes	Maximum temperature	260 °C

Accessories included for Main Oven & Hob

Cast iron wok support	1	40mm deep tray	1
Moka stand in cast iron	1	Grill mesh	1
Rack with back and side stop	1	Catalytic panels	3
20mm deep tray	1		

Electrical Connection

Plug	Not present	Voltage 2 (V)	380-415 V
Electrical connection rating	3200 W	Power supply cable length	120 cm
Current	14 A	Frequency	50/60 Hz
Voltage	220-240 V	Terminal block	3 poles

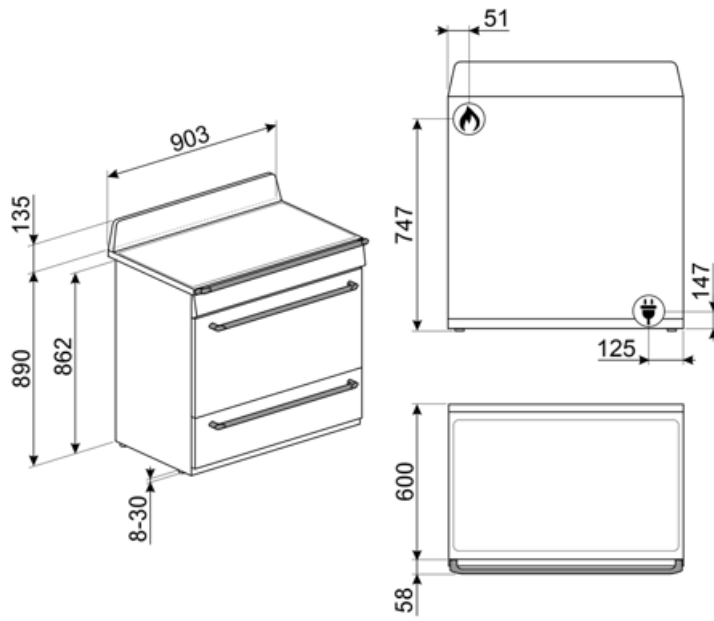

Not included accessories

AIRFRY9

Air fryer rack AIRFRY . Ideal for recreating traditional frying in the oven, but with fewer calories and less fat. It allows you to cook quickly and simply dishes such as French fries, fried vegetables and fish, ensuring perfect browning and crispiness.



PRTX

Refractory pizza stone with handles. D=35cm Not suitable for microwave ovens. Suitable for gas ovens, to be put on the griddle.



PPR9

Refractory pizza stone without handles. Squared shaped stone: L64xH2,3xP37,5 cm Suitable also for gas ovens, to be put on the griddle.



BBQ9



KITHTR90

Height extension kit (950mm), black, suitable for Victoria TR90 cookers (945-960mm)



GTT

Totally extractable telescopic guides (1 level), suitable for traditional ovens. Made in stainless steel, they guarantee stability and facilitate the smooth extraction of the trays.



GTP

Partially extractable telescopic guides (1 level), suitable for traditional ovens. Made in stainless steel, they guarantee stability and facilitate the smooth extraction of the trays.



BGTR9

Cast iron grill plate suitable for 90 cm Victoria, 60 and 90 cm Master and Sinfonia cookers



KIT1TR9N

Splashback black, 90cm ,suitable for TR90 and TR93 Victoria cookers



KITROT9

Rotisserie kit for 90x60 cookers, new cavity (115 L)



PALPZ

Pizza shovel with folding handle. Dimensions L31.5 x H32.5 cm. Easy and convenient to use and store. Perfect for serving pizza, bread and savory pastries in a safe and professional way.







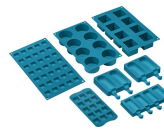























SMOLD

Set of 7 silicone moulds for ice creams, ice lollies, pralines, ice cubes or to portion food. Usable from -60°C to +230°C



Symbols glossary (TT)

 <p>Heavy duty cast iron pan stands: for maximum stability and strength.</p>	 <p>Catalytic cleaning: the system ensures perfect hygiene inside the oven thanks to the three self-cleaning panels coated with a special enamel that promotes the progressive elimination of traces of grease and odors caused by cooking.</p>
	 <p>Installation in column: Installation in column</p>
 <p>Air cooling system: to ensure a safe surface temperatures.</p>	 <p>Defrost by time: Manual defrost function. At the end of the set duration, the function stops.</p>
 <p>Triple glazed doors: Number of glazed doors.</p>	 <p>Ever Clean Enamel: Ever Clean enamel is applied electrostatically, corner to corner and edge to edge to prevent cracking or cracks over time. It is a particular pyrolytic enamel, resistant to acids which, in addition to being pleasantly bright, promotes greater cleaning of the oven walls, thanks to its lower porosity. It is baked at over 850 ° C and slowly polymerized at a scientifically determined rate to ensure uniform depth and strength Ever Clean enamel creates an impeccable finish both on the inside of the oven and on the trays, making the surfaces of the oven incredibly easy to maintain over time as it reduces the adhesion of fat during cooking</p>
 <p>Fan assisted base: the mix of fan and lower heating element alone allows to finish cooking foods already cooked on the surface but not internally more quickly. This system is recommended to finish cooking foods that are already well cooked on the surface, but not internally, which therefore require a moderate higher heat. Ideal for any type of food.</p>	 <p>Fan assisted: Intense and homogeneous traditional cooking, also suitable for complex recipes. The fan is active and the heat comes from below and from above at the same time. Ventilated cooking ensures a faster and more homogeneous result, leaving fragrant foods outside and moister inside. Ideal for baked pasta, biscuits, roasts and cobblers.</p>
 <p>Static: Traditional cooking suitable for the preparation of one dish at a time. The fan is not active and the heat comes from below and from above at the same time. Static cooking is slower and more delicate, ideal in order to get well cooked and dry dishes even inside. Ideal for cooking all types of roasts, fatty meats, bread, filled cakes.</p>	 <p>Base: the heat comes only from the bottom of the cavity. The fan is not active. Ideal for sweet and savory pies, cobblers and pizzas. Designed to complete cooking and make food more crunchy This symbol in gas ovens indicates the gas burner.</p>
 <p>Circulaire: it is the perfect function for cooking all types of dishes in a more delicate way. The heat comes from the back of the oven and is distributed quickly and evenly The fan is active. It is also ideal for cooking on multiple levels without mixing smells and flavors.</p>	 <p>ECO: low energy consumption cooking: this function is particularly suitable for cooking on a single shelf with low energy consumption. It is recommended for all types of food except those that can generate a lot of moisture (for example vegetables). To achieve maximum energy savings and reduce time, it is recommended to put the food in the oven without preheating the cooking compartment</p>

-
- | | | | |
|--|--|---|--|
|  | Grill: Very intense heat coming only from above from a double heating element. The fan is not active. Provides excellent grilling and gratinating results. Used at the end of cooking, it gives a uniform browning to dishes. |  | Fan grill: very intense heat coming only from above from a double heating element The fan is active. It allows the optimal grilling of thickest meats. Ideal for large cuts of meat. |
|  | Rotisserie: The rotisserie (where installed) works in combination with the grill element to brown foods to perfection. |  | Gas ovens offer instantaneous heat control, reduced cooking times and the ability to bake at much lower temperatures than electric ovens. |
|  | All glass inner door: All glass inner door, a single flat surface which is simple to keep clean. |  | The inner door glass: can be removed with a few quick movements for cleaning. |
|  | Side lights: Two opposing side lights increase visibility inside the oven. |  | Automatic opening: some models have Automatic opening door when the cycle is finished which is a perfect solution for handle-less kitchen units as no handle is needed. For safety reasons, the door locks automatically when the machine is in use to avoid it being opened inadvertently. |
|  | The oven cavity has 5 different cooking levels. |  | Soft close: all models are equipped with advanced function of smooth closing of the door, which allows the device to close smoothly and quietly. |
|  | Ultra rapid burners: Powerful ultra rapid burners offer up to 5kw of power. |  | Vapor Clean: a simple cleaning function using steam to loosen deposits in the oven cavity. |
|  | The capacity indicates the amount of usable space in the oven cavity in litres. |  | Knobs control |

Benefit (TT)

True-convection

The best cooking performances guaranteed by ventilated circular flow

Multiple fans and heating elements guarantee the perfect aerodynamic heat flow, allowing homogeneous and quicker cooking inside the cavity.

Gas hob

Gas provides permanent control of the heat source and the temperature change is immediate

Equipped with a thermocouple, the gas supply is cut off if the flame is extinguished for greater safety.

Catalysis

Easy oven cleaning through the use of catalytic panels in the cavity

This permanent process allows continuous cleaning and degreasing of the three cavity walls, starting its grease oxidation phase when the oven reaches 200°C.

Isothermic Cavity

The best cooking performance at the highest energy efficiency

Double Turbine

The oven has two fans equipped with two circular heating elements allowing cooking with rotating heat

Tangential cooling

New cooling system with tangential fan and airflow from the door to the splashback

Soft close

The door is equipped with a specific system for silent closing

Multilevel halogen light

Internal halogen lighting on different levels guarantees excellent visibility

Buttons control

Easy and intuitive timer setting with a simple buttons

Adjustable height

Cooker top flushed with the working area thanks to adjustable feet

Removable inner glass

Internal door glasses are easily removable for complete cleaning

Multilevel cooking

Several cooking levels allow maximum flexibility of use

Cold door

During any function, the external door glass is cold, avoiding any risk of burns

AirFry (AIRFRY optional accessory)

Lighter and tastier food thanks to airfry basket (optional accessory)

Drawer storage compartment

More space thanks to the lower drawer compartment, ideal for storing accessories or cooking utensils

BBQ (optional accessory)

Barbeque cooking directly in the oven with the double-sided grill (BBQ optional accessory)

Pizza stone (optional accessory)

Baking with refractory stone for soft and crispy pizza and yeast products (STONE optional accessory)