

TR90GMBL

Cooker size	90x60 cm
N. of cavities with energy label	1
Cavity heat source	ELECTRICITY
Hob type	Gas
Type of main oven	Thermo-ventilated
Cleaning system main oven	Vapor Clean
EAN code	8017709344788
Energy efficiency class	A



Aesthetics











Design	Victoria	Controls colour	Stainless steel
Command panel finish	Enamelled metal	No. of controls	8
Aesthetic	Victoria	Serigraphy colour	Silver
Logo	assembled 50's	Display name	Electronic 5 buttons
Colour	Black	Door	With frame
Logo position	Upstand+ Command panel	Glass type	Black
Finishing	Glossy	Handle	Smeg Victoria
Upstand	Yes	Handle Colour	Polished chrome
Hob colour	Black enamel	Storage compartment	Push pull
Type of pan stands	Cast Iron	Feet color	none
Type of control setting hob	Control knobs	Plinth	Anthracite
Type of control knobs	Smeg Victoria		

Programs / Functions main oven

No. of cooking functions 9

Traditional cooking functions

 Static	 Fan assisted	 Circulaire
 Eco	 Small grill	 Large grill
 Fan grill (large)	 Base	 Fan assisted base

Other functions

 Defrost by time

Cleaning functions

 Vapor clean

Hob technical features

UR

Total no. of cook zones 5

Front left - Gas - Rapid - 2.90 kW

Rear left - Gas - Semi Rapid - 1.80 kW

Central - Gas - 2UR (dual) - 5.00 kW

Rear right - Gas - Semi Rapid - 1.80 kW

Front right - Gas - AUX - 1.00 kW

Type of gas burners Standard

Gas safety valves Yes

Automatic electronic ignition Yes

Burner caps Matt black enamelled

Main Oven Technical Features



No. of lights 2

Fan number 2

Net volume of the cavity 115 l

Gross volume, 1st cavity 129 l

Cavity material Ever Clean enamel

No. of shelves 5

Type of shelves Metal racks

Light type Halogen

Light Power 40 W

Cooking time setting Start and Stop

Light when oven door is open Yes

Door opening Flap down

Removable door Yes

Full glass inner door Yes

Removable inner door Yes

Total no. of door glasses 3

No. of thermo-reflective door glasses 2

Safety Thermostat Yes

Cooling system Tangential

Usable cavity space dimensions (HxWxD) 371x724x418 mm

Temperature control Electro-mechanical

Lower heating element power 1700 W

Upper heating element - Power 1200 W

Grill element 1700 W

Large grill - Power 2900 W

Circular heating element - Power 2 x 1550 W

Grill type Electric

Soft Close system Yes

Options Main Oven

Timer Yes

End of cooking acoustic alarm Yes

Minimum Temperature 50 °C

Maximum temperature 260 °C

Accessories included for Main Oven & Hob

Cast iron wok support	1	20mm deep tray	1
Moka stand in cast iron	1	40mm deep tray	1
Rack with back and side stop	1	Grill mesh	1

Electrical Connection

Electrical connection rating	3200 W	Power supply cable length	110 cm
Current	14 A	Frequency	50/60 Hz
Voltage	220-240 V	Terminal block	3 poles
Voltage 2 (V)	380-415 V	Plug	Not present
Electric cable	Installed, Single phase		

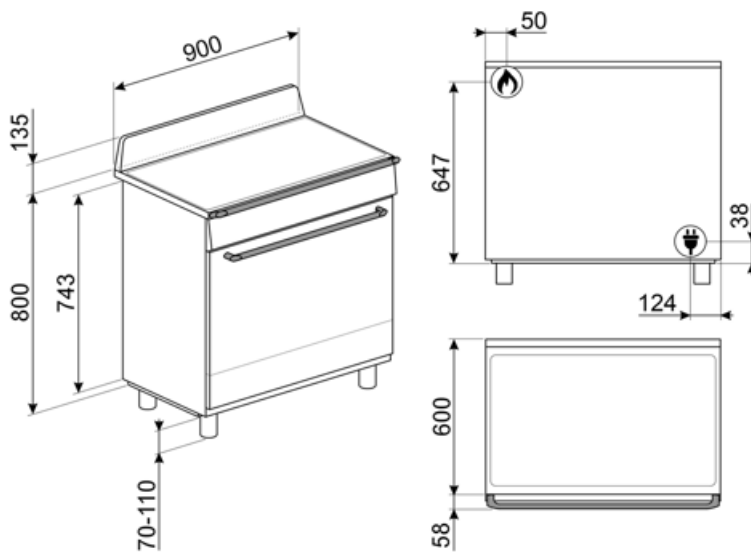

Compatible Accessories

AIRFRY9

Air fryer rack AIRFRY . Ideal for recreating traditional frying in the oven, but with fewer calories and less fat. It allows you to cook quickly and simply dishes such as French fries, fried vegetables and fish, ensuring perfect browning and crispiness.



BN920

Enamelled tray 90cm cavity, 20mm deep



GTP

Partially extractable telescopic guides (1 level), suitable for traditional ovens. Made in stainless steel, they guarantee stability and facilitate the smooth extraction of the trays.



KIT1TR9N

Splashback black, 90cm ,suitable for TR90 and TR93 Victoria cookers



PALPZ

Pizza shovel with folding handle. Dimensions L31.5 x H32.5 cm. Easy and convenient to use and store. Perfect for serving pizza, bread and savory pastries in a safe and professional way.



SMOLD

Set of 7 silicone moulds for ice creams, ice lollies, pralines, ice cubes or to portion food. Usable from -60°C to +230°C

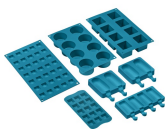

BBQ9

teflon-coated aluminum grid for 90 cm cavity



BN940

Enamelled tray 90 cm, 40 mm deep



GTT

Totally extractable telescopic guides (1 level), suitable for traditional ovens. Made in stainless steel, they guarantee stability and facilitate the smooth extraction of the trays.



KITH95CPF9

Height extension kit with plinth, (950mm), three sides, black with feet, suitable for CPF9 Portofino and Sinfony C9 cookers



SFLK1

Child lock



Alternative products



TR90GMGR















Colour: Slate Grey















TR90GMP

Colour: Cream

Symbols glossary

 <p>Heavy duty cast iron pan stands: for maximum stability and strength.</p>	 <p>Energy efficiency class A</p>
 <p>Installation in column: Installation in column.</p>	 <p>Knobs control</p>
 <p>Air cooling system: to ensure a safe surface temperatures.</p>	 <p>Defrost by time: Manual defrost function. At the end of the set duration, the function stops.</p>
 <p>Triple glazed doors: Number of glazed doors.</p>	 <p>Ever Clean Enamel: Ever Clean enamel is applied electrostatically, corner to corner and edge to edge to prevent cracking or cracks over time. It is a particular pyrolytic enamel, resistant to acids which, in addition to being pleasantly bright, promotes greater cleaning of the oven walls, thanks to its lower porosity. It is baked at over 850 °C and slowly polymerized at a scientifically determined rate to ensure uniform depth and strength. Ever Clean enamel creates an impeccable finish both on the inside of the oven and on the trays, making the surfaces of the oven incredibly easy to maintain over time as it reduces the adhesion of fat during cooking.</p>
 <p>Fan assisted base: the mix of fan and lower heating element alone allows to finish cooking foods already cooked on the surface but not internally more quickly. This system is recommended to finish cooking foods that are already well cooked on the surface, but not internally, which therefore require a moderate higher heat. Ideal for any type of food.</p>	 <p>Fan assisted: Intense and homogeneous traditional cooking, also suitable for complex recipes. The fan is active and the heat comes from below and from above at the same time. Ventilated cooking ensures a faster and more homogeneous result, leaving fragrant foods outside and moister inside. Ideal for baked pasta, biscuits, roasts and cobblers.</p>
 <p>Static: Traditional cooking suitable for the preparation of one dish at a time. The fan is not active and the heat comes from below and from above at the same time. Static cooking is slower and more delicate, ideal in order to get well cooked and dry dishes even inside. Ideal for cooking all types of roasts, fatty meats, bread, filled cakes.</p>	 <p>Base: the heat comes only from the bottom of the cavity. The fan is not active. Ideal for sweet and savory pies, cobblers and pizzas. Designed to complete cooking and make food more crunchy. This symbol in gas ovens indicates the gas burner.</p>
 <p>Circulaire: it is the perfect function for cooking all types of dishes in a more delicate way. The heat comes from the back of the oven and is distributed quickly and evenly. The fan is active. It is also ideal for cooking on multiple levels without mixing smells and flavors.</p>	 <p>ECO: low energy consumption cooking: this function is particularly suitable for cooking on a single shelf with low energy consumption. It is recommended for all types of food except those that can generate a lot of moisture (for example vegetables). To achieve maximum energy savings and reduce time, it is recommended to put the food in the oven without preheating the cooking compartment.</p>

-
- | | |
|--|---|
|  <p>Grill: Very intense heat coming only from above from a double heating element. The fan is not active. Provides excellent grilling and gratinating results. Used at the end of cooking, it gives a uniform browning to dishes.</p> |  <p>Half grill: For rapid cooking and browning of foods. Best results can be obtained by using the top shelf for small items, the lower shelves for larger ones, such as chops or sausages. For half grill heat is generated only at the centre of the element, so is ideal for smaller quantities.</p> |
|  <p>Fan grill: very intense heat coming only from above from a double heating element. The fan is active. It allows the optimal grilling of thickest meats. Ideal for large cuts of meat.</p> |  <p>All glass inner door: All glass inner door, a single flat surface which is simple to keep clean.</p> |
|  <p>The inner door glass: can be removed with a few quick movements for cleaning.</p> |  <p>Side lights: Two opposing side lights increase visibility inside the oven.</p> |
|  <p>Automatic opening: some models have Automatic opening door when the cycle is finished which is a perfect solution for handle-less kitchen units as no handle is needed. For safety reasons, the door locks automatically when the machine is in use to avoid it being opened inadvertently.</p> |  <p>The oven cavity has 5 different cooking levels.</p> |
|  <p>Soft close: all models are equipped with advanced function of smooth closing of the door, which allows the device to close smoothly and quietly.</p> |  <p>Ultra rapid burners: Powerful ultra rapid burners offer up to 5kw of power.</p> |
|  <p>Vapor Clean: a simple cleaning function using steam to loosen deposits in the oven cavity.</p> |  <p>The capacity indicates the amount of usable space in the oven cavity in litres.</p> |