

TR90GPBL

Categorie fornuis	90x60 cm
N. of cavities with energy label	1
Cavity heat source	Elektriciteit
Type kookplaat	Gas
Type primaire oven	Thermogeventileerd
Reinigingssysteem primaire oven	Pyrolyse reiniging
EAN-code	8017709345129
Energie-efficiëntieklasse	A+



Design



Design	Victoria	Kleur bedieningsknoppen	Inox
Afwerking bedieningspaneel	Gekleurd plaatstaal	Aantal bedieningsknoppen	8
Design Logo	Victoria assembled 50's	Kleur serigrafie	Zilver
Kleur	Zwart	Display	Elektronisch 5 toetsen
Positie logo	Upstand+ Bedieningspaneel	Deur	Met kader
Afwerking	Glanzend	Type glas	Zwart
Upstand	Ja	Handgreep	Smeg Victoria
Kleur kookplaat	Black enamel	Kleur handgreep	Gepolijst chroom
Type pottendragers	Gietijzeren pottendragers	Opbergruimte	Opbergvak met klep
Bediening	Bedieningsknoppen	Pootjes	Geen
Bedieningsknoppen	Smeg Victoria	Plint	Zwart

Programma's / Functies

Aantal kookfuncties	9
---------------------	---

Traditionele bereidingsfuncties

Statisch	Geventileerd	Circulatie (ventilator + circulaire)
Turbo	ECO	Kleine grill
Grote grill	Ventilator + grote grill	Geventileerde onderwarmte

Reinigingsfuncties

Pyrolyse

Technische specificaties kookplaat

UR			
Totaal aantal kookzones	5		
Linksvoor - Gas - RP	2.90 kW		
Linksachter - Gas - SRD	1.80 kW		
Midden - Gas - 2URP (dual)	5.00 kW		
Rechtsachter - Gas - SRD	1.80 kW		
Rechtsvoor - Gas - AUX	1.00 kW		
Type gasbranders	Standaard	Thermobeveiliging	Ja
Automatische vonkontsteking	Ja	Branderdeksels	Mat zwart geëmailleerd

Technische specificaties primaire oven

Aantal lampen	2	Aantal ventilatoren	2	Netto volume 1e oven	115 l	Aantal ruiten ovendeur	4	Aantal thermo-reflecterende ruiten	2	Veiligheidsthermostaat	Ja	Koelsysteem	Mantelkoeling
Bruto volume, oven 1	129 l	Materiaal ovenruimte	Ever Clean emaille	Aantal kookniveaus	5	Deurblokkering tijdens pyrolyse	Ja	Afmetingen bruikbare interne ovenruimte (hxbxd)	371x724x418 mm	Temperatuurregeling	Elektro-mechanisch	Onderwarmte - vermogen	1700 W
Type ovenrekken	Metalen zijsteunen	Type licht	Halogeen	Vermogen lamp	40 W	Onderwarmte - vermogen	1700 W	Bovenwarmte - vermogen	1200 W	Grill - vermogen	1700 W	Grote vlakgrill - vermogen	2900 W
Opties bereidingstijdprogrammering	Begin en eind	Automatische inschakeling verlichting bij openen deur	Ja	Opening deur	Neerwaarts	Circulatie - vermogen	2 x 2000 W						

Grill type	Elektrisch
Soft close systeem	Ja

Opties primaire oven

Timer	Ja	Minimum temperatuur	50 °C
Geluidssignaal einde kooktijd	Ja	Maximum temperatuur	260 °C

Meegeleverde accessoires primaire oven en kookplaat

Gietijzeren wokring	1	Bakplaat (20 mm)	1
Gietijzeren houder t.b.v. caffettiera	1	Bakplaat (40 mm)	1
Ovenrooster met stop	1	Inzetrooster	1

Elektrische aansluiting

Nominale aansluitwaarde	4200 W	Type stroomkabel	Double and Three Phase
Stroom	19 A	Frequentie	50/60 Hz
Spanning	220-240 V	Connection box	5 polig
Spanning 2 (V)	380-415 V	Stekker	Nee
Electric cable	Installed, Single phase		

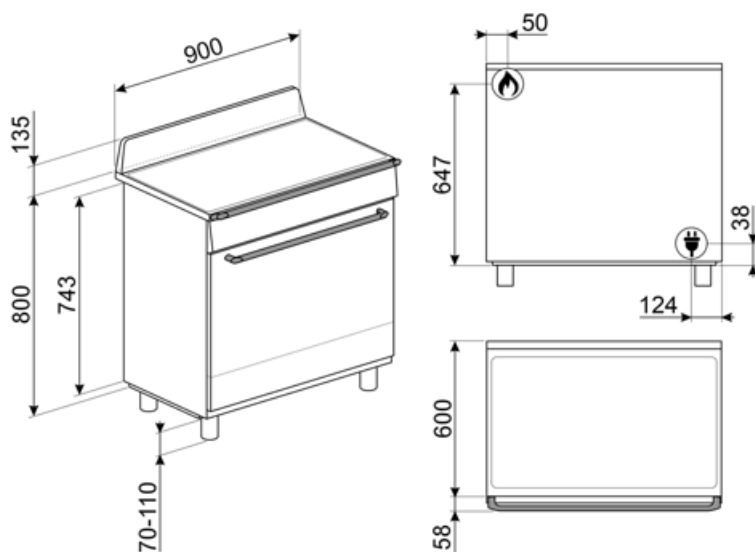

Compatible Accessories

AIRFRY9

Air fryer rack AIRFRY . Ideal for recreating traditional frying in the oven, but with fewer calories and less fat. It allows you to cook quickly and simply dishes such as French fries, fried vegetables and fish, ensuring perfect browning and crispiness.



BN920

Enamelled tray 90cm cavity, 20mm deep



GTP

Partially extractable telescopic guides (1 level), suitable for traditional ovens. Made in stainless steel, they guarantee stability and facilitate the smooth extraction of the trays.



KIT1TR9N

Splashback black, 90cm ,suitable for TR90 and TR93 Victoria cookers



PALPZ

Pizzapallet inox met ploibaar handvat, 315x325 mm



SMOLD

Set van 7 siliconen vormen voor ijsjes, pralines, ijsblokjes of porties. -60°C tot 230°C.

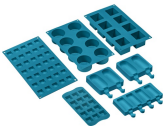

BBQ9

teflon-coated aluminum grid for 90 cm cavity



BN940

Enamelled tray 90 cm, 40 mm deep



GTT

Volledig uitschuifbare telescopische rails (1 niveau) voor traditionele ovens (SF-).



KITH95CPF9

Height extension kit with plinth, (950mm), three sides, black with feet, suitable for CPF9 Portofino and Sinfony C9 cookers



SFLK1

Child lock



Alternative products



TR90GPP









Kleur: Crème













TR90GPR

Kleur: Leigrijs

Symbols glossary

- | | |
|--|--|
|  <p>Heavy duty cast iron pan stands: for maximum stability and strength.</p> |  <p>A+: Energy efficiency class A+ helps to save up to 10% energy compared to class A. Maximum performance with minimum consumption is guaranteed.</p> |
|  <p>Installation in column: Installation in column.</p> |  <p>Air cooling system: to ensure a safe surface temperatures.</p> |
|  <p>Quadruple glazed: Number of glazed doors.</p> |  <p>Ever Clean Enamel: Ever Clean enamel is applied electrostatically, corner to corner and edge to edge to prevent cracking or cracks over time. It is a particular pyrolytic enamel, resistant to acids which, in addition to being pleasantly bright, promotes greater cleaning of the oven walls, thanks to its lower porosity. It is baked at over 850 °C and slowly polymerized at a scientifically determined rate to ensure uniform depth and strength. Ever Clean enamel creates an impeccable finish both on the inside of the oven and on the trays, making the surfaces of the oven incredibly easy to maintain over time as it reduces the adhesion of fat during cooking.</p> |
|  <p>Circogas: In gasovens verdeelt de ventilator de warmte snel en gelijkmatig over de ovenruimte, waardoor smaakoverdracht wordt vermeden bij het tegelijkertijd bereiden van een aantal verschillende gerechten. In elektrische ovens voltooit deze combinatie het koken van voedsel dat aan de oppervlakte klaar is, maar dat van binnen meer moet worden gekookt, zonder verder bruin te worden.</p> |  <p>Ventilator met bovenste en onderste elementen: De elementen in combinatie met de ventilator zijn bedoeld om een meer gelijkmatige warmte te bieden, een methode die vergelijkbaar is met conventioneel koken, dus voorverwarmen is vereist. Het meest geschikt voor items die langzaam koken vereisen.</p> |
|  <p>Alleen boven- en onder element: een traditionele kookmethode die het meest geschikt is voor losse items in het midden van de oven. de bovenkant van de oven zal altijd het heetst zijn. Ideaal voor gebraden vlees, fruitcake, brood etc.</p> |  <p>Circulaire: De combinatie van de ventilator en het ronde element eromheen zorgt voor een hete lucht kookmethode. Dit biedt vele voordelen, waaronder geen voorverwarmen als de kooktijd meer dan 20 minuten bedraagt, geen smaakoverdracht bij het gelijktijdig bereiden van verschillende soorten voedsel, minder energie en kortere kooktijden. Geschikt voor alle soorten voedsel.</p> |
|  <p>De combinatie van de grill, de ventilator en onderwarmte is interessant voor het bereiden van kleine hoeveelheden.</p> |  <p>Grill: Very intense heat coming only from above from a double heating element. The fan is not active. Provides excellent grilling and gratinating results. Used at the end of cooking, it gives a uniform browning to dishes.</p> |
|  <p>Half grill: For rapid cooking and browning of foods. Best results can be obtained by using the top shelf for small items, the lower shelves for larger ones, such as chops or sausages. For half grill heat is generated only at the centre of the element, so is ideal for smaller quantities.</p> |  <p>Fan grill: very intense heat coming only from above from a double heating element. The fan is active. It allows the optimal grilling of thickest meats. Ideal for large cuts of meat.</p> |

-  Circulaire met bovenste en onderste elementen: door het gebruik van de ventilator met beide elementen kan voedsel snel en effectief worden gekookt, ideaal voor grote stukken vlees die grondig moeten worden gekookt. Het biedt een vergelijkbaar resultaat als rotisserie, waarbij de warmte rond het voedsel wordt verplaatst in plaats van het voedsel zelf te verplaatsen, waardoor elke maat of vorm kan worden gekookt.
-  The inner door glass: can be removed with a few quick movements for cleaning.
-  Automatic opening: some models have Automatic opening door when the cycle is finished which is a perfect solution for handle-less kitchen units as no handle is needed. For safety reasons, the door locks automatically when the machine is in use to avoid it being opened inadvertently.
-  The oven cavity has 5 different cooking levels.
-  Ultra rapid burners: Powerful ultra rapid burners offer up to 5kw of power.
-  Knobs control
-  All glass inner door: All glass inner door, a single flat surface which is simple to keep clean.
-  Side lights: Two opposing side lights increase visibility inside the oven.
-  **PYROLYSIS - AUTOMATIC CLEANING FUNCTION:** the oven heats up to a temperature approaching 500 ° C and chars grease and food residues into a fine ash that can be easily wiped off with a damp cloth. At such a high temperature, the door locks automatically for safety, while the temperature of the door remains controlled so it is safe to touch User adjustable function based on the level of dirt present in the oven.
-  Alle modellen zijn voorzien van een soft close deursysteem waarbij de deur zacht en stil sluit.
-  The capacity indicates the amount of usable space in the oven cavity in litres.