

TR90GR2

Cooker size	90x60 cm
N. of cavities with energy label	1
Cavity heat source	ELECTRICITY
Hob type	Gas
Type of main oven	Thermo-ventilated
Cleaning system main oven	Catalytic
EAN code	8017709322120
Energy efficiency class	A



Aesthetics











Aesthetic	Victoria	No. of controls	8
Colour	Slate Grey	Serigraphy colour	Silver
Design	Victoria	Handle	Smeg Victoria
Door	With frame	Handle Colour	Polished chrome
Upstand	Yes	Glass type	Black
Type of pan stands	Cast Iron	Feet	none
Hob colour	Black enamel	Plinth	Anthracite
Command panel finish	Enamelled metal	Storage compartment	Drawer
Control knobs	Smeg Victoria	Sliding compartment	Yes
Controls colour	Stainless steel	Logo	assembled 50's
Display	electronic 5 buttons	Logo position	Upstand+ Command panel
Colour of buttons	Black		

Programme / Functions

No. of cooking functions 9

Traditional cooking functions

 Static	 Fan assisted	 Circulaire
 Eco	 Small grill	 Large grill
 Fan grill (large)	 Base	 Fan assisted bottom

Cleaning functions

Catalytic

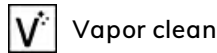

Other functions



Defrost by time

Hob technical features



Total no. of cook zones 5

Front left - Gas - Rapid - 2.90 kW

Rear left - Gas - Semi Rapid - 1.80 kW

Central - Gas - 2UR (dual) - 5.00 kW

Rear right - Gas - Semi Rapid - 1.80 kW

Front right - Gas - AUX - 1.00 kW

Type of gas burners Standard

Gas safety valves Yes

Automatic electronic ignition Yes

Burner caps Matt black enamelled

Main Oven Technical Features

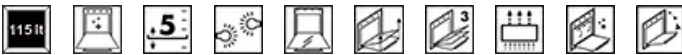

No. of lights 2

Fan number 2

Net volume of the cavity 115 l

Gross volume, 1st cavity 129 l

Cavity material Ever Clean enamel

No. of shelves 5

Type of shelves Metal racks

Light type Halogen

Light Power 40 W

Cooking time setting Start and Stop

Light when oven door is open Yes

Door opening Flap down

Removable door Yes

Full glass inner door Yes

Removable inner door Yes

Total no. of door glasses 3

No. of thermo-reflective door glasses 2

Safety Thermostat Yes

Cooling system Tangential

Usable cavity space dimensions (HxWxD) 371x724x418 mm

Temperature control Electro-mechanical

Lower heating element power 1700 W

Upper heating element - Power 1200 W

Grill element 1700 W

Large grill - Power 2900 W

Circular heating element - Power 2 x 1550 W

Grill type Electric

Tilting grill Yes

Soft Close system Yes

Options Main Oven

Timer Yes

Minimum Temperature 50 °C

Maximum temperature 260 °C

End of cooking acoustic alarm Yes

Accessories included for Main Oven & Hob

Cast iron wok support	1	40mm deep tray	1
Moka stand in cast iron	1	Grill mesh	1
Rack with back and side stop	1	Catalytic panels	3
20mm deep tray	1		

Electrical Connection

Electrical connection rating	3200 W	Frequency	50/60 Hz
Current	14 A	Power supply cable length	120 cm
Voltage	220-240 V	Terminal block	3 poles

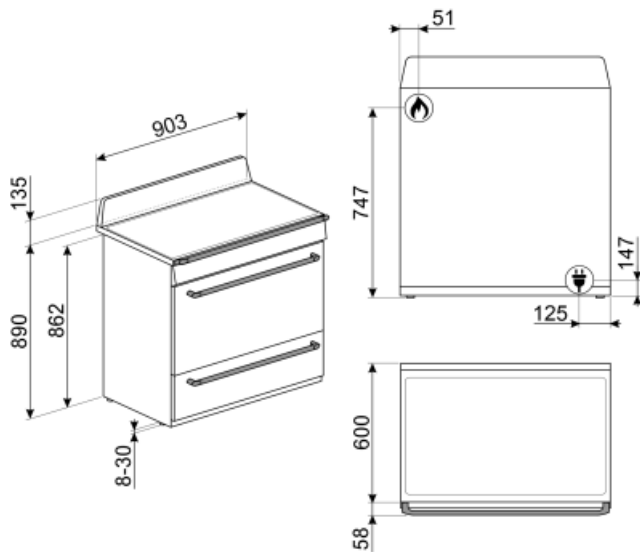

Not included accessories



TPKTR9

Stainless steel teppanyaki plate, suitable for Victoria TR9, Master and Sinfonia cookers



PRTX

Refractory pizza stone with handles. D=35cm Not suitable for microwave ovens. Suitable for gas ovens, to be put on the griddle.



PPR9

Refractory pizza stone without handles. Squared shaped stone: L64xH2,3xP37,5 cm Suitable also for gas ovens, to be put on the griddle.



GT1P-2

Partially extractable telescopic guides (1 level) for ovens with metal frames. Length: 355.5 mm, extraction: 285 mm. Material: Stainless steel AISI 430 polished.



KIT1TR9X

Splashback st/steel, 90cm ,suitable for TR90 and TR93 Victoria cookers



GTT

Totally extractable telescopic guides (1 level), suitable for traditional ovens. Made in stainless steel, they guarantee stability and facilitate the smooth extraction of the trays.



GTP

Partially extractable telescopic guides (1 level), suitable for traditional ovens. Made in stainless steel, they guarantee stability and facilitate the smooth extraction of the trays.



BGTR9

Cast iron grill plate suitable for 90 cm Victoria, 60 and 90 cm Master and Sinfonia cookers



KIT1TR9N

Splashback black, 90cm ,suitable for TR90 and TR93 Victoria cookers



KITHTR90

Height extension kit (950mm), black, suitable for Victoria TR90 cookers (945-960mm)



PALPZ



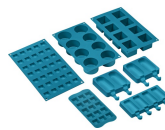











Pizza shovel with folding handle. Dimensions L31.5 x H32.5 cm. Easy and convenient to use and store. Perfect for serving pizza, bread and savory pastries in a safe and professional way.













SMOLD

Set of 7 silicone moulds for ice creams, ice lollies, pralines, ice cubes or to portion food. Usable from -60°C to +230°C

Symbols glossary (TT)

 <p>A: Product drying performance, measured from A+++ to D / G depending on the product family</p>	 <p>Heavy duty cast iron pan stands: for maximum stability and strength.</p>
 <p>Air cooling system: to ensure a safe surface temperatures.</p>	 <p>Defrost by time: Manual defrost function. At the end of the set duration, the function stops.</p>
 <p>Triple glazed doors: Number of glazed doors.</p>	 <p>Ever Clean Enamel: Ever Clean enamel is applied electrostatically, corner to corner and edge to edge to prevent cracking or cracks over time. It is a particular pyrolytic enamel, resistant to acids which, in addition to being pleasantly bright, promotes greater cleaning of the oven walls, thanks to its lower porosity. It is baked at over 850 ° C and slowly polymerized at a scientifically determined rate to ensure uniform depth and strength Ever Clean enamel creates an impeccable finish both on the inside of the oven and on the trays, making the surfaces of the oven incredibly easy to maintain over time as it reduces the adhesion of fat during cooking</p>
 <p>Fan assisted base: the mix of fan and lower heating element alone allows to finish cooking foods already cooked on the surface but not internally more quickly. This system is recommended to finish cooking foods that are already well cooked on the surface, but not internally, which therefore require a moderate higher heat. Ideal for any type of food.</p>	 <p>Fan assisted: Intense and homogeneous traditional cooking, also suitable for complex recipes. The fan is active and the heat comes from below and from above at the same time. Ventilated cooking ensures a faster and more homogeneous result, leaving fragrant foods outside and moister inside. Ideal for baked pasta, biscuits, roasts and cobblers.</p>
 <p>Static: Traditional cooking suitable for the preparation of one dish at a time. The fan is not active and the heat comes from below and from above at the same time. Static cooking is slower and more delicate, ideal in order to get well cooked and dry dishes even inside. Ideal for cooking all types of roasts, fatty meats, bread, filled cakes.</p>	 <p>Base: the heat comes only from the bottom of the cavity. The fan is not active. Ideal for sweet and savory pies, cobblers and pizzas. Designed to complete cooking and make food more crunchy This symbol in gas ovens indicates the gas burner.</p>
 <p>Circulaire: it is the perfect function for cooking all types of dishes in a more delicate way. The heat comes from the back of the oven and is distributed quickly and evenly The fan is active. It is also ideal for cooking on multiple levels without mixing smells and flavors.</p>	 <p>ECO: low energy consumption cooking: this function is particularly suitable for cooking on a single shelf with low energy consumption. It is recommended for all types of food except those that can generate a lot of moisture (for example vegetables). To achieve maximum energy savings and reduce time, it is recommended to put the food in the oven without preheating the cooking compartment</p>
 <p>Grill: Very intense heat coming only from above from a double heating element. The fan is not active. Provides excellent grilling and gratinating results. Used at the end of cooking, it gives a uniform browning to dishes.</p>	 <p>Half grill: For rapid cooking and browning of foods. Best results can be obtained by using the top shelf for small items, the lower shelves for larger ones, such as chops or sausages. For half grill heat is generated only at the centre of the element, so is ideal for smaller quantities.</p>

-
- | | | | |
|--|---|---|--|
|  | Fan grill: very intense heat coming only from above from a double heating element. The fan is active. It allows the optimal grilling of thickest meats. Ideal for large cuts of meat. |  | All glass inner door: All glass inner door, a single flat surface which is simple to keep clean. |
|  | The inner door glass: can be removed with a few quick movements for cleaning. |  | Side lights: Two opposing side lights increase visibility inside the oven. |
|  | The oven cavity has 5 different cooking levels. |  | Soft close: all models are equipped with advanced function of smooth closing of the door, which allows the device to close smoothly and quietly. |
|  | Tilting grill: the tilting grill can be easily unhooked to move the heating element and clean the roof of the appliance in one simple step. |  | Ultra rapid burners: Powerful ultra rapid burners offer up to 5kw of power. |
|  | Vapor Clean: a simple cleaning function using steam to loosen deposits in the oven cavity. |  | The capacity indicates the amount of usable space in the oven cavity in litres. |