

# TR90IBL2

Cooker size	90x60 cm
N. of cavities with energy label	1
Cavity heat source	ELECTRICITY
Hob type	Induction
Type of main oven	Thermoseal
Cleaning system main oven	Vapour Clean
EAN code	8017709312350
Energy efficiency class	A











## Aesthetics

			
<b>Design</b>	Victoria	<b>No. of controls</b>	7
<b>Command panel finish</b>	Enamelled metal	<b>Serigraphy colour</b>	Silver
<b>Aesthetic</b>	Victoria	<b>Display</b>	electronic 5 buttons
<b>Logo</b>	assembled 50's	<b>Door</b>	With frame
<b>Colour</b>	Black	<b>Glass type</b>	Black
<b>Logo position</b>	Upstand+ Command panel	<b>Handle</b>	Smeg Victoria
<b>Finishing</b>	Glossy	<b>Handle Colour</b>	Polished chrome
<b>Upstand</b>	Yes	<b>Storage compartment</b>	Drawer
<b>Hob colour</b>	Black enamel	<b>Sliding compartment</b>	Yes
<b>Type of control setting</b>	Control knobs	<b>Feet</b>	none
<b>Control knobs</b>	Smeg Victoria	<b>Plinth</b>	Anthracite
<b>Controls colour</b>	Stainless steel		

## Programs / Functions

No. of cooking functions 9  
 Traditional cooking functions

 Static	 Fan assisted	 Circulaire
 Eco	 Small grill	 Large grill
 Fan grill (large)	 Base	 Fan assisted bottom

## Other functions

 Defrost by time

## Cleaning functions

Catalytic

 Vapour Clean

## Hob options



Control lock	Yes	Limited Power	3700, 4800, 7400 W
Limited Power Consumption Mode	Yes	Consumption Mode in W	

## Hob technical features



**Total no. of cook zones** 5

Front left - Induction - single - 1.30 kW - Booster 1.40 kW - Ø 18.0 cm

Rear left - Induction - single - 2.30 kW - Booster 3.00 kW - Ø 21.0 cm

Central - Induction - single - 2.30 kW - Booster 3.00 kW - Ø 27.0 cm

Rear right - Induction - single - 1.30 kW - Booster 1.40 kW - Ø 18.0 cm

Front right - Induction - single - 2.30 kW - Booster 3.00 kW - Ø 21.0 cm

Automatic switch off when overheat	Yes	Minimum pan diameter indication	Yes
Automatic pan detection	Yes	Selected zone indicator	Yes

## Main Oven Technical Features



No. of lights	2	Removable inner door	Yes
Fan number	2	Total no. of door glasses	3
Net volume of the cavity	115 l	No. of thermo-reflective door glasses	2
Gross volume, 1st cavity	129 l	Safety Thermostat	Yes
Cavity material	Ever Clean enamel	Cooling system	Tangential
No. of shelves	5	Usable cavity space dimensions (HxWxD)	371x724x418 mm
Type of shelves	Metal racks	Temperature control	Electro-mechanical
Light type	Halogen	Lower heating element power	1700 W
Light Power	40 W	Upper heating element - Power	1200 W
Cooking time setting	Start and Stop	Grill element	1700 W
Light when oven door is open	Yes	Large grill - Power	2900 W
Door opening	Flap down		
Removable door	Yes		
Full glass inner door	Yes		

---

<b>Circular heating element - Power</b>	1550 W
<b>Grill type</b>	Electric
<b>Soft Close system</b>	Yes

## Options Main Oven

---

<b>Timer</b>	Yes	<b>Minimum Temperature</b>	50 °C
<b>End of cooking acoustic alarm</b>	Yes	<b>Maximum temperature</b>	260 °C

## Accessories included for Main Oven & Hob

---

<b>Rack with back and side stop</b>	1	<b>Grill mesh</b>	1
<b>20mm deep tray</b>	1	<b>Catalitic panels</b>	3
<b>40mm deep tray</b>	1		

## Electrical Connection

---

<b>Electrical connection rating</b>	10600 W	<b>Type of electric cable</b>	Yes, Double and Three Phase
<b>Current</b>	46 A	<b>Frequency</b>	50/60 Hz
<b>Voltage</b>	220-240 V	<b>Terminal block</b>	5 poles
<b>Voltage 2 (V)</b>	380-415 V	<b>Plug</b>	No
<b>Type of electric cable installed</b>	Yes, Single phase		

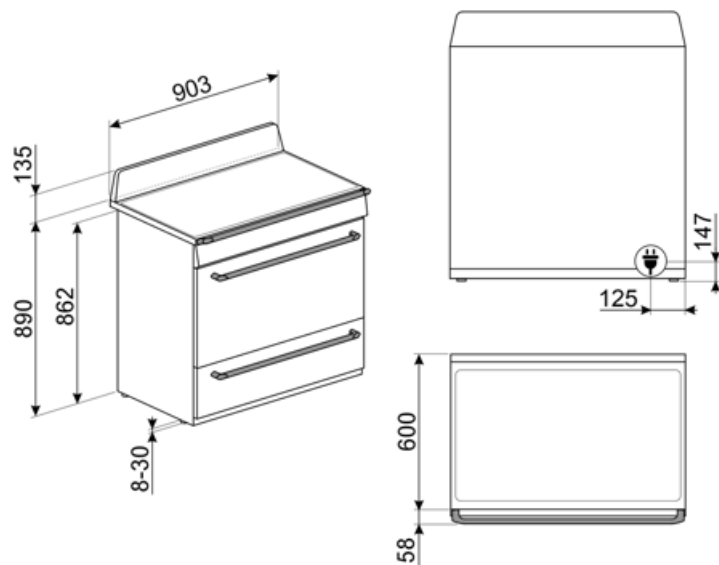

## Compatible Accessories

### AIRFRY9

Air fryer rack AIRFRY . Ideal for recreating traditional frying in the oven, but with fewer calories and less fat. It allows you to cook quickly and simply dishes such as French fries, fried vegetables and fish, ensuring perfect browning and crispiness.



### BN920

Enamelled tray 90cm cavity, 20mm deep



### GRILLPLATE

Universal griddle for induction, gas, ceramic and electric hobs. Non-stick surface ideal for cooking meat, cheese and vegetables. Dimensions: 410 x 240 mm.



### GTT

\*\*Totally extractable telescopic guides (1 level)\*\* Extraction: 433 mm Material: Stainless steel AISI 430 polished



### PALPZ

Pizza shovel with fold away handle width: 315mm length : 325mm



### SMOLD

Set of 7 silicone moulds for ice creams, ice lollies, pralines, ice cubes or to portion food. Usable from -60°C to +230°C

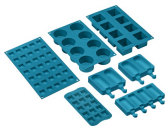

### BBQ9

teflon-coated aluminum grid for 90 cm cavity



### BN940

Enamelled tray 90 cm, 40 mm deep



### GTP

\*\*Partially extractable telescopic guides (1 level)\*\* Extraction: 300 mm Material: Stainless steel AISI 430 polished



### KIT1TR9N

Splashback, 90x75 cm suitable for TR9 Victoria cookers, black



### SCRP

Induction and ceramic hobs and teppanyaki scraper































### TPKPLATE

Universal plate for induction, gas, ceramic and electric hobs. Non-stick surface ideal for cooking fish, eggs and vegetables. Dimensions: 410 X 240 mm.



## Symbols glossary

 <p>Child lock: some models are fitted with a device to lock the programme/cycle so it cannot be accidentally changed.</p>	 <p>A: Product drying performance, measured from A+++ to D / G depending on the product family</p>
 <p>Installation in column: Installation in column</p>	 <p>Knobs control</p>
 <p>Air cooling system: to ensure a safe surface temperatures.</p>	 <p>Defrost by time: with this function the time of thawing of foods are determined automatically.</p>
 <p>Triple glazed doors: Number of glazed doors.</p>	 <p>ECO-logic: option allows you to restrict the power limit of the appliance real energy saving.</p>
 <p>Enamel interior: The enamel interior of all Smeg ovens have a special antacid lining which helps keep the interior clean by reducing the amount of cooking grease adhering to it.</p>	 <p>Fan assisted base: the mix of fan and lower heating element alone allows to finish cooking foods already cooked on the surface but not internally more quickly. This system is recommended to finish cooking foods that are already well cooked on the surface, but not internally, which therefore require a moderate higher heat. Ideal for any type of food.</p>
 <p>Fan with upper and lower elements: The elements combined with the fan aim to provide more uniform heat, a similar method to conventional cooking, so pre-heat is required. Most suitable for items requiring slow cooking methods.</p>	 <p>Upper and lower element only: a traditional cooking method best suited for single items located in the centre of the oven. the top pf the oven will always be hottest. Ideal for roast, fruit cakes, bread etc.</p>
 <p>Lower heating element only: This function is ideal for foods that require extra base temperature without browning, e.g. pastry dishes, pizza. Also suitable for slow cooking of stews and casseroles.</p>	 <p>Circulaire: The combination of the fan and circular element around it gives a hot air cooking method. This provides many benefits including no preheat if cook time is more than 20 minutes, no flavour transfer when cooking different foods at the same time, less energy, and shorter cook times. Good for all types of food.</p>
 <p>ECO: The combination of the grill, fan and lower element is particularly suitable for cooking small quantities of food.</p>	 <p>Grill element: Using of grill gives excellent results when cooking meat of medium and small portions, especially when combined with a rotisserie (where possible). Also ideal for cooking sausages and bacon.</p>
 <p>Half grill: For rapid cooking and browning of foods. Best results can be obtained by using the top shelf for small items, the lower shelves for larger ones, such as chops or sausages. For half grill heat is generated only at the centre of the element, so is ideal for smaller quantities.</p>	 <p>Fan with grill element: The fan reduces the fierce heat from the grill, providing an excellent method of grilling various foods, chops, steaks, sausages etc. giving even browning and heat distribution, without drying out the food. The top two levels recommended for use, and the lower part of the oven can be used to keep items warm at the same time, an excellent facility when cooking a grilled breakfast. Half grill (centre portion only) is ideal for small quantities of food.</p>

- 
- |   |  |
|---|--|
|  <p>Overheat protection: The safety system that automatically turns off the hob in case of overheating of the control unit.</p> |  <p>Induction: The work of these hobs is based on the principle of electromagnetic induction. The heat is generated directly in the bottom of the pan during its contact with the hob.</p>  |
|  <p>All glass inner door: All glass inner door, a single flat surface which is simple to keep clean.</p>                        |  <p>The inner door glass: can be removed with a few quick movements for cleaning.</p>   |
|  <p>Side lights: Two opposing side lights increase visibility inside the oven.</p>  |  <p>Automatic opening: some models have Automatic opening door when the cycle is finished which is a perfect solution for handle-less kitchen units as no handle is needed. For safety reasons, the door locks automatically when the machine is in use to avoid it being opened inadvertently.</p> |
|  <p>The oven cavity has 5 different cooking levels.</p>   |  <p>Soft close: all models are equipped with advanced function of smooth closing of the door, which allows the device to close smoothly and quietly.</p>  |
|  <p>Vapour Clean: a simple cleaning function using steam to loosen deposits in the oven cavity.</p>                             |  <p>The capacity indicates the amount of usable space in the oven cavity in litres.</p>   |