

## TR90IP2

|                                 |                    |
|---------------------------------|--------------------|
| Categorie fornuis               | 90x60 cm           |
| Aantal ovens met energielabel   | 1                  |
| Cavity heat source              | Elektrisch         |
| Type kookplaat                  | Inductie           |
| Type primaire oven              | Thermogeventileerd |
| Reinigingssysteem primaire oven | Vapor Clean        |
| EAN-code                        | 8017709312480      |
| Energie-efficiëntieklasse       | A                  |



## Design

|  |                              |                          |                        |
|--|------------------------------|--------------------------|------------------------|
|  |                              |                          |                        |
| Esthetiek  | Victoria                     | Aantal bedieningsknoppen | 7                      |
| Design   | Victoria                     | Kleur serigrafie         | Zwart                  |
| Kleur  | Crème                        | Display                  | Elektronisch 5 toetsen |
| Afwerking  | Crème                        | Deur                     | Met kader              |
| Afwerking bedieningspaneel   | Gekleurd plaatstaal          | Type glas                | Zwart                  |
| Logo   | assembled 50's               | Handgreep                | Smeg Victoria          |
| Positie logo   | Upstand+<br>Bedieningspaneel | Kleur handgreep          | Glanzend chroom        |
| Upstand  | Ja                           | Opbergruimte             | Lade                   |
| Kleur kookplaat  | Zwart glanzend               | Lade                     | Ja                     |
| Type bediening   | Bedieningsknoppen            | Pootjes                  | Geen                   |
| Bedieningsknoppen  | Smeg Victoria                | Plint                    | Antraciet              |
| Kleur knoppen  | Roestvrij staal              |                          |                        |

## Programma's / functies

|                     |   |
|---------------------|---|
| Aantal kookfuncties | 9 |
|---------------------|---|

## Traditionele kookfuncties

|  |  |   |
|--|--|---|
|  Statisch          |  Geventileerd |  Circulaire        |
|  ECO               |  Kleine grill |  Grote vlak-grill  |
|  Fan grill (large) |  Base         |  Fan assisted base |



## Schoonmaak functie

|             |   |
|-------------|---|
| Katalytisch |  Vapor Clean |
|-------------|---|

## Overige functies

|  |
|--|
|  Ontdooien op tijd |
|--|

## Opties kookplaat

|   |  |                           |                    |
|---|--|---------------------------|--------------------|
|  |  |                           |                    |
| Kinderbeveiliging   | Ja   | ECO-Logic optie - stappen | 3700, 4800, 7400 W |
| ECO-Logic optie   | Ja   |                           |                    |

## Technische specificaties kookplaat



### Totaal aantal kookzones 5

Linksvoor - Inductie - enkel - 1.30 kW - Booster 1.40 kW - Ø 18.0 cm  
 Linksachter - Inductie - enkel - 2.30 kW - Booster 3.00 kW - Ø 21.0 cm  
 Midden - Inductie - enkel - 2.30 kW - Booster 3.00 kW - Ø 27.0 cm  
 Rechtsachter - Inductie - enkel - 1.30 kW - Booster 1.40 kW - Ø 18.0 cm  
 Rechtsvoor - Inductie - enkel - 2.30 kW - Booster 3.00 kW - Ø 21.0 cm

|                                      |    |  |    |
|--------------------------------------|----|--|----|
| Automatische stop bij oververhitting | Ja | Indicator minimaal te gebruiken diameter | Ja |
| Automatische aanpassing panafmeting  | Ja | Indicator geselecteerde zone             | Ja |

## Technische specificaties primaire oven



|                      |                    |                                    |    |
|----------------------|--------------------|------------------------------------|----|
| Aantal lampen        | 2                  | Uitneembaar glas binnendeur        | Ja |
| Aantal ventilatoren  | 2                  | Aantal ruiten ovendeur             | 3  |
| Netto inhoud         | 115 l              | Aantal thermo-reflecterende ruiten | 2  |
| Bruto inhoud 1e oven | 129 l              |                                    |    |
| Materiaal ovenruimte | Ever Clean emaille |                                    |    |

|  |                    |  |                    |
|--|--------------------|--|--------------------|
| <b>Aantal kookniveaus</b>                                    | 5                  | <b>Veiligheidsthermostaat</b>                          | Ja                 |
| <b>Type ovenrekken</b>                                       | Metalen zijsteunen | <b>Koelsysteem</b>                                     | Mantelkoeling      |
| <b>Soort verlichting</b>                                     | Halogeen           | <b>Afmetingen bruikbare interne ovenruimte (hxbxd)</b> | 371x724x418 mm     |
| <b>Vermogen lamp</b>   | 40 W               | <b>Temperatuurregeling</b>                             | Elektro-mechanisch |
| <b>Instelling kooktijd</b>                                   | Start en stop      | <b>Onderwarmte - vermogen</b>                          | 1700 W             |
| <b>Automatische inschakeling verlichting bij openen deur</b> | Ja                 | <b>Bovenwarmte - vermogen</b>                          | 1200 W             |
| <b>Deur openen</b>   | naar beneden       | <b>Grill - vermogen</b>                                | 1700 W             |
| <b>Uitneembare ovendeur</b>                                  | Ja                 | <b>Grote vlakgrill - vermogen</b>                      | 2900 W             |
| <b>Volledig glazen binnendeur</b>                            | Ja                 | <b>Circulatie - vermogen</b>                           | 1550 W             |
|  |                    | <b>Type grill</b>                                      | Elektrisch         |
|  |                    | <b>Soft close systeem</b>                              | Ja                 |

## Opties primaire oven

|  |    |                            |        |
|--|----|----------------------------|--------|
| <b>Timer</b>                             | Ja | <b>Minimum temperatuur</b> | 50 °C  |
| <b>Akoestisch signaal einde kooktijd</b> | Ja | <b>Maximum temperatuur</b> | 260 °C |

## Meegeleverde accessoires primaire oven en kookplaat

|                                   |   |                                |   |
|-----------------------------------|---|--------------------------------|---|
| <b>Rek met achter- en zijstop</b> | 1 | <b>Inzetrooster</b>            | 1 |
| <b>Bakplaat (20 mm)</b>           | 1 | <b>Katalyse-emaille wanden</b> | 3 |
| <b>Bakplaat (40 mm)</b>           | 1 |                                |   |

## Elektrische aansluiting

|                       |           |                         |                         |
|-----------------------|-----------|-------------------------|-------------------------|
| <b>Aansluitwaarde</b> | 10600 W   | <b>Electric cable</b>   | Installed, Single phase |
| <b>Stroom</b>         | 46 A      | <b>Type stroomkabel</b> | Double and Three Phase  |
| <b>Spanning</b>       | 220-240 V | <b>Frequentie</b>       | 50/60 Hz                |
| <b>Spanning 2 (V)</b> | 380-415 V | <b>Aansluitkast</b>     | 5 polig                 |

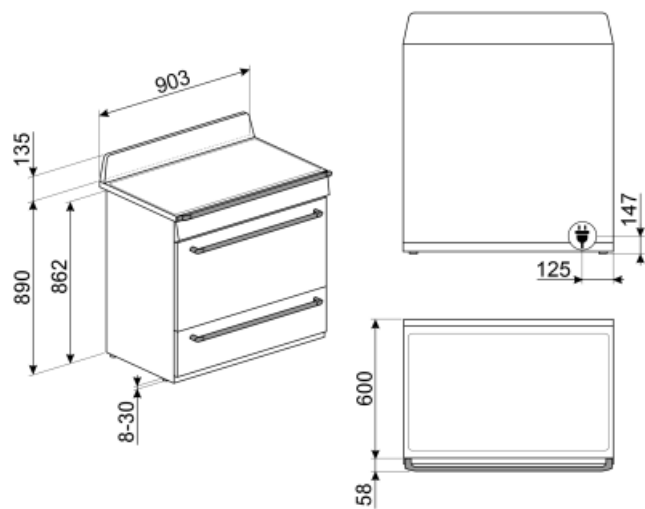

## Accessoires niet inbegrepen

### AIRFRY9

Air fryer rack AIRFRY . Ideal for recreating traditional frying in the oven, but with fewer calories and less fat. It allows you to cook quickly and simply dishes such as French fries, fried vegetables and fish, ensuring perfect browning and crispiness.



### PRTX

Ronde pizzasteen met handvaten, diameter 35 cm



### PPR9

Refractory pizza stone without handles. Squared shaped stone: L64xH2,3xP37,5 cm Suitable also for gas ovens, to be put on the griddle.



### BBQ9



### KITHTR90

Height extension kit (950mm), black, suitable for Victoria TR90 cookers (945-960mm)



### PALPZ

Pizzaschep met inklapbare handgreep breedte: 315 mm lengte: 325 mm



### SMOLD

Set van 7 siliconen vormpjes voor ijsjes, ijslolly's, pralines, ijsblokjes of om etenswaren te portioneren. Bruikbaar van -60 ° C tot + 230 ° C

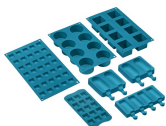

### GTP

Gedeeltelijk uittrekbare telescopische geleiders (1 niveau)



### GRILLPLATE

Universal griddle for induction, gas, ceramic and electric hobs. Non-stick surface ideal for cooking meat, cheese and vegetables. Dimensions: 410 x 240 mm.



### KIT1TR9N

Splashback black, 90cm ,suitable for TR90 and TR93 Victoria cookers



### SCRP

Inductie- en keramische kookplaten en teppanyaki-schraper



### TPKPLATE

Universal plate for induction, gas, ceramic and electric hobs. Non-stick surface ideal for cooking fish, eggs and vegetables. Dimensions: 410 X 240 mm.































### GTT

Volledig uittrekbare telescopische geleiders (1 niveau)



## Symbols glossary (TT)

|  |  |
|--|--|
|  <p>Kinderslot: sommige modellen zijn voorzien van een apparaat om het programma / de cyclus te vergrendelen zodat het niet kan per ongeluk veranderd</p>  |  <p>A: Droogprestaties van het product, gemeten vanaf A +++ tot D / G afhankelijk van de productfamilie</p>   |
|  <p>Installation in column: Installation in column</p>   |  <p>Luchtkoelsysteem: om een veilig oppervlak te garanderen temperaturen.</p>   |
|  <p>Ontdooien op tijd: met deze functie wordt automatisch het tijdstip van ontdooien van voedsel bepaald</p>   |  <p>Deuren met driedubbele beglazing: aantal glazen deuren.</p>   |
|  <p>ECO-logic: optie stelt u in staat om de vermogenslimiet van de werkelijke energiebesparing van het apparaat te beperken</p>  |  <p>Geëmailleerde binnenkant: De geëmailleerde binnenkant van alle Smeg-ovens heeft een speciale antacidumvoering die helpt om de binnenkant schoon te houden door de hoeveelheid kookvet te verminderen.</p>   |
|  <p>Fan assisted base: the mix of fan and lower heating element alone allows to finish cooking foods already cooked on the surface but not internally more quickly. This system is recommended to finish cooking foods that are already well cooked on the surface, but not internally, which therefore require a moderate higher heat. Ideal for any type of food.</p>  |  <p>Ventilator met bovenste en onderste elementen: de elementen in combinatie met de ventilator zijn bedoeld om een meer gelijkmatige warmte te bieden, een methode die vergelijkbaar is met conventioneel koken, dus voorverwarmen is vereist. Het meest geschikt voor items die langzaam koken vereisen.</p>  |
|  <p>De ovenruimte wordt tegelijk door het onder- en bovinelement verwarmt. De hitteverdeling over het gerecht is afhankelijk van het niveau waarop men dit plaatst. Geschikt voor bakken op 1 niveau. Gerechten: alle ovenschotels, vlees, gevogelte, brood, (gevulde) taarten. Speciaal: gans en eend (bevatten veel vet).</p>  |  <p>De ovenruimte wordt uitsluitend verhit door het onderelement. Voor gerechten die een hoge basistemperatuur behoeven, heeft deze bakstand weinig tot geen invloed op de korst aan de bovenzijde. Geschikt voor bakken op 1 niveau, ideaal voor deeggerechten die moeten rijzen (bijv. pizza). Bij gevulde taarten zal de deegbodem beter droog blijven.</p>  |
|  <p>Circulaire: it is the perfect function for cooking all types of dishes in a more delicate way. The heat comes from the back of the oven and is distributed quickly and evenly The fan is active. It is also ideal for cooking on multiple levels without mixing smells and flavors.</p>  |  <p>ECO: low energy consumption cooking: this function is particularly suitable for cooking on a single shelf with low energy consumption. It is recommended for all types of food except those that can generate a lot of moisture (for example vegetables). To achieve maximum energy savings and reduce time, it is recommended to put the food in the oven without preheating the cooking compartment</p> |
|  <p>De warmte wordt geproduceerd door het grill- en bovinelement. Verhitting over het volledige oppervlak. De thermostaat wordt, afhankelijk van het gerecht, in de regel op de maximale stand gezet. Bij een korte baktijd kan de ovendeur gesloten blijven; bij langere baktijd blijft deze gedeeltelijk geopend. Voor vleesgerechten (klein- en middelgroot), vleespennen, vis, groenten, gratineren etc.</p> |  <p>De warmte is alleen afkomstig van het grill-element. Verhitting over een kleiner oppervlak. Te gebruiken als de grote vlak-grill, maar voor kleinere hoeveelheden</p>   |

-  Ventilator met grillelement: De ventilator vermindert de felle hitte van de grill en biedt een uitstekende methode om verschillende soorten voedsel, karbonades, steaks, worstjes enz. Te grillen, waardoor het gelijkmatig bruin wordt en de warmte wordt verdeeld, zonder het voedsel uit te drogen. De bovenste twee niveaus die voor gebruik worden aanbevolen, en het onderste deel van de oven kunnen worden gebruikt om gerechten tegelijkertijd warm te houden, een uitstekende mogelijkheid bij het bereiden van een gegrild ontbijt. Halve grill (alleen middengedeelte) is ideaal voor kleine hoeveelheden voedsel.
-  Induction: The work of these hobs is based on the principle of electromagnetic induction. The heat is generated directly in the bottom of the pan during its contact with the hob.
-  The inner door glass: can be removed with a few quick movements for cleaning.
-  Automatic opening: some models have Automatic opening door when the cycle is finished which is a perfect solution for handle-less kitchen units as no handle is needed. For safety reasons, the door locks automatically when the machine is in use to avoid it being opened inadvertently.
-  Soft close: all models are equipped with advanced function of smooth closing of the door, which allows the device to close smoothly and quietly.
-  The capacity indicates the amount of usable space in the oven cavity in litres.
-  Overheat protection: The safety system that automatically turns off the hob in case of overheating of the control unit.
-  All glass inner door: All glass inner door, a single flat surface which is simple to keep clean.
-  verlichting
-  The oven cavity has 5 different cooking levels.
-  Vapor Clean: a simple cleaning function using steam to loosen deposits in the oven cavity.
-  Knobs control

## Benefit (TT)

---

### True-convection

The best cooking performances guaranteed by ventilated circular flow

Multiple fans and heating elements guarantee the perfect aerodynamic heat flow, allowing homogeneous and quicker cooking inside the cavity.

### Catalysis

Easy oven cleaning through the use of catalytic panels in the cavity

This permanent process allows continuous cleaning and degreasing of the three cavity walls, starting its grease oxidation phase when the oven reaches 200°C.

### Induction hob

Induction offers fast cooking and precise temperature control

Through the use of suitable cookware, induction is easy to use and maintain, safe and responsive.

### Vapor Clean

By inserting water into a recess at the bottom of the cavity, steam is generated, which softens the residue and facilitates its removal

By inserting water into a recess at the bottom of the cavity, steam is generated, which softens the residue and facilitates its removal.

### Isothermic Cavity

The best cooking performance at the highest energy efficiency

### Double Turbine

The oven has two fans equipped with two circular heating elements allowing cooking with rotating heat

### Tangential cooling

New cooling system with tangential fan and airflow from the door to the splashback

### Soft close

The door is equipped with a specific system for silent closing

### Multilevel halogen light

Internal halogen lighting on different levels guarantees excellent visibility

### Buttons control

Easy and intuitive timer setting with a simple buttons



### **Adjustable height**

Cooker top flushed with the working area thanks to adjustable feet

### **Removable inner glass**

Internal door glasses are easily removable for complete cleaning

### **Multilevel cooking**

Several cooking levels allow maximum flexibility of use

### **Cold door**

During any function, the external door glass is cold, avoiding any risk of burns

### **AirFry (AIRFRY optional accessory)**

Lighter and tastier food thanks to airfry basket (optional accessory)

### **Drawer storage compartment**

More space thanks to the lower drawer compartment, ideal for storing accessories or cooking utensils

### **BBQ (optional accessory)**

Barbeque cooking directly in the oven with the double-sided grill (BBQ optional accessory)

### **Pizza stone (optional accessory)**

Baking with refractory stone for soft and crispy pizza and yeast products (STONE optional accessory)