

TR90X9-1

Cooker size	90x60 cm
N.º de cavidades com rótulo energético	1
Fonte de calor da cavidade	ELECTRICITY
Hob type	Gas
Tipo de forno principal	Thermo-ventilated
Sistema de limpeza no forno principal	Catalytic
EAN code	8017709293772
Energy efficiency class	A



Aesthetics











Aesthetic	Victoria	Controls colour	Stainless steel
Design	Victoria	No. of controls	8
Colour	Stainless steel	Cor da serigrafia	Serigrafia em preto
Acabamento	Satin	Display	electronic 5 buttons
Command panel finish	Enamelled metal	Door	With frame
Logo	Logotipo Anni 50	Glass type	Black
Posição do logotipo	Logotipo na zona da placa+ Logotipo no painel de comandos	Handle	Smeg Victoria
Upstand	Yes	Handle Colour	Polished chrome
Cor da placa	Esmalte preto	Storage compartment	Drawer
Type of pan stands	Cast Iron	Sliding compartment	Yes
Type of control setting	Control knobs	Feet	none
Control knobs	Smeg Victoria	Plinth	Anthracite

Programs / Functions

No. of cooking functions	9
--------------------------	---

Traditional cooking functions

 Static	 Fan assisted	 Circulaire
 Eco	 Large grill	 Fan grill (large)
 Base	 Fan assisted bottom	 Rotisserie

Other functions

 Defrost by time
--

Recipes No













Cleaning functions

Catalytic	 Vapor clean
-----------	---

Hob technical features

 UR			
Total no. of cook zones	5		
Front left - Gas - Rapid	2.90 kW		
Rear left - Gas - Semi Rapid	1.80 kW		
Central - Gas - 2UR (dual)	5.00 kW		
Rear right - Gas - Semi Rapid	1.80 kW		
Front right - Gas - AUX	1.00 kW		
Type of gas burners	Standard	Gas safety valves	Yes
Automatic electronic ignition	Yes	Burner caps	Matt black enamelled

Main Oven Technical Features

													
No. of lights	2	Total no. of door glasses	3	No. of thermo-reflective door glasses	2	Safety Thermostat	Yes	Heating suspended when door is opened	Yes	Cooling system	Tangential	Usable cavity space dimensions (HxWxD)	371x724x418 mm
Fan number	2	Net volume of the cavity	115 l	Gross volume, 1st cavity	129 l	Cavity material	Ever Clean enamel	No. of shelves	5	Type of shelves	Metal racks	Roof Liner	No
Light type	Halogen	Light Power	40 W	Cooking time setting	Start and Stop	Light when oven door is open	Yes	Door opening	Flap down	Removable door	Yes	Temperature control	Electro-mechanical
Lower heating element power	1700 W	Upper heating element - Power	1200 W	Grill element	1700 W	Large grill - Power	2900 W						

Full glass inner door	Yes	Circular heating element	2 x 1550 W
Removable inner door	Yes	- Power	
		Grill type	Electric
		Tilting grill	Yes
		Soft Close system	Yes

Options Main Oven

Timer	Yes	Minimum Temperature	50 °C
End of cooking acoustic alarm	Yes	Maximum temperature	260 °C

Accessories included for Main Oven & Hob

Cast iron wok support	1	40mm deep tray	1
Moka stand in cast iron	1	Grill mesh	1
Rack com batente traseiro e lateral	1	Catalityc panels	3
20mm deep tray	1		

Electrical Connection

Plug	No	Voltage 2 (V)	380-415 V
Electrical connection rating	3200 W	Comprimento do cabo de alimentação	120 cm
Current	14 A	Frequency	50/60 Hz
Voltage	220-240 V	Bloco de terminais	3 polos

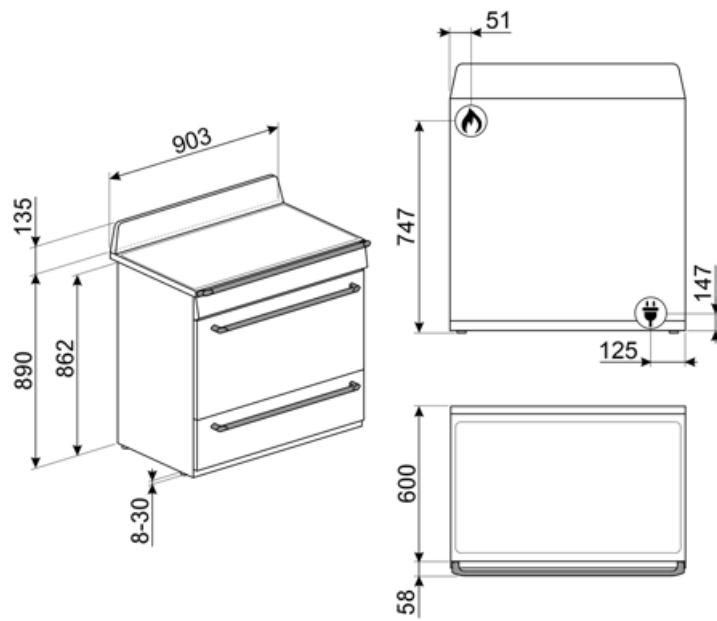

Compatible Accessories

AIRFRY9

Air fryer rack AIRFRY . Ideal for recreating traditional frying in the oven, but with fewer calories and less fat. It allows you to cook quickly and simply dishes such as French fries, fried vegetables and fish, ensuring perfect browning and crispiness.



BGTR9

Placa para grelhar de ferro fundido adequada para fogões Victoria 90 cm, Master e Sinfonia de 60 e 90 cm



BN940

GTT

** Guias telescópicas totalmente extraíveis (1 nível)** Extração: 433 mm Material: Aço inoxidável AISI 430 polido



KITHTR90

Kit extensão de altura (950 mm), adequado para fogões Victoria TR90



PALPZ

Pá para pizza com alça dobrável largura: 315mm comprimento : 325mm



SMOLD

Conjunto de 7 moldes de silicone para sorvetes, gelados, pralinés, cubos de gelo ou para porção de alimentos. Utilizável de -60°C a +230°C

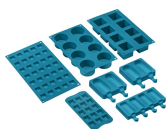

BBQ9



BN920

GTP

** Guias telescópicas parcialmente extraíveis (1 nível)** Extração: 300 mm Material: Aço inoxidável AISI 430 polido



KIT1TR9N

Painel anti-salpicos, 90x75 cm adequado para fogões Victoria TR9, preto



KITROT9

Kit Rotisseria para fogões 90x60, nova cavidade (115 L)































PPR9

Pedra para pizza refratária sem pegas. Pedra em forma quadrada: L64xH2,3xP37,5 cm Adequada também para fornos a gás, para ser colocada na grelha.



Symbols glossary

-  Suportes de ferro fundido para serviço pesado: para máxima estabilidade e resistência.
-  R: Desempenho de secagem do produto, medido de A++ a D/G, dependendo da família de produtos
-  Controle dos botões
-  Descongela pelo tempo: com esta função, o tempo de descongelamento dos alimentos é determinado automaticamente.
-  Interior esmaltado: O interior em esmalte de todos os fornos Smeg tem um revestimento antiácido especial que ajuda a manter o interior limpo, reduzindo a quantidade de gordura de cozimento aderente a ele.
-  Ventilador com elementos superiores e inferiores: Os elementos combinados com o ventilador visam fornecer calor mais uniforme, um método semelhante ao cozimento convencional, de modo que o pré-aquecimento é necessário. Mais adequado para itens que exigem métodos de cozimento lento.
-  Apenas elemento de aquecimento inferior: Esta função é ideal para alimentos que exigem uma temperatura de base extra sem escurecimento, por exemplo, pratos de pastelaria, pizza. Também adequado para cozinhar lentamente ensopados e caçarolas.
-  ECO: A combinação da grelha, ventilador e elemento inferior é particularmente adequada para cozinhar pequenas quantidades de alimentos.
-  Limpeza catalítica: o sistema garante uma higiene perfeita no interior do forno graças aos três painéis de autolimpeza revestidos com um esmalte especial que promove a eliminação progressiva de vestígios de gordura e odores causados pelo cozimento.
-  Instalação em coluna: Instalação em coluna
-  Sistema de arrefecimento a ar: para garantir temperaturas de superfície seguras.
-  Portas envidraçadas triplas: Número de portas envidraçadas.
-  Circogas: Em fornos a gás, o ventilador distribui o calor de forma rápida e uniforme por toda a cavidade do forno, evitando a transferência de sabor ao cozinhar vários pratos diferentes ao mesmo tempo. Em fornos elétricos, esta combinação completa o cozimento mais rapidamente de alimentos que estão prontos na superfície, mas que exigem mais cozimento no interior, sem mais escurecimento.
-  Somente elementos superior e inferior: um método de cozimento tradicional mais adequado para itens individuais localizados no centro do forno. A parte superior do forno será sempre mais quente. Ideal para assados, bolos de frutas, pão, etc.
-  Circulaire: A combinação do ventilador e do elemento circular em torno dele dá um método de cozimento de ar quente. Isso oferece muitos benefícios, incluindo nenhum pré-aquecimento se o tempo de cozimento for superior a 20 minutos, nenhuma transferência de sabor ao cozinhar alimentos diferentes ao mesmo tempo, menos energia e tempos de cozimento mais curtos. Bom para todos os tipos de alimentos.
-  Elemento de grelha O uso de grelha dá excelentes resultados ao cozinhar carne de porções médias e pequenas, especialmente quando combinada com uma rotisseria (sempre que possível). Também é ideal para cozinhar salsichas e bacon.

-  Ventilador com elemento de grelha: O ventilador reduz o calor feroz da grelha, proporcionando um excelente método de grelhar vários alimentos, costeletas, bifés, salsichas, etc. dando o mesmo escurecimento e distribuição de calor, sem secar os alimentos. Os dois níveis superiores recomendados para uso e a parte inferior do forno podem ser usados para manter os itens quentes ao mesmo tempo, uma excelente facilidade ao cozinhar um café da manhã grelhado. Meia grelha (apenas porção central) é ideal para pequenas quantidades de alimentos.
-  Toda a porta interna de vidro: Toda a porta interna de vidro, uma única superfície plana que é simples de manter limpa.
-  Luzes laterais: Duas luzes laterais opostas aumentam a visibilidade dentro do forno.
-  O compartimento do forno tem 5 níveis de cozimento diferentes.
-  Grelha basculante: a grelha basculante pode ser facilmente desengatada para mover o elemento de aquecimento e limpar o tejadilho do aparelho em um simples passo.
-  Limpeza a Vapor: uma função de limpeza simples que utiliza vapor para afrouxar os depósitos no compartimento do forno.
-  Rotisseria: A rotisseria (quando instalada) funciona em combinação com o elemento de grelha para alimentos assados com perfeição.
-  O vidro interior da porta: pode ser removido com alguns movimentos rápidos para limpeza.
-  Abertura automática: alguns modelos têm porta de abertura automática quando o ciclo é terminado, o que é uma solução perfeita para unidades de cozinha sem alça, pois nenhuma alça é necessária. Por razões de segurança, a porta trava automaticamente quando a máquina está em uso para evitar que seja aberta inadvertidamente.
-  Fechamento suave: todos os modelos estão equipados com função avançada de fechamento suave da porta, o que permite que o dispositivo feche suave e silenciosamente.
-  Queimadores ultrarrápidos: Queimadores ultrarrápidos potentes oferecem até 5kw de potência.
-  A capacidade indica a quantidade de espaço útil no compartimento do forno em litros.

Benefit (TT)

Gas hob

Gas provides permanent control of the heat source and the temperature change is immediate

Equipped with a thermocouple, the gas supply is cut off if the flame is extinguished for greater safety.

Catalysis

Easy oven cleaning through the use of catalytic panels in the cavity

This permanent process allows continuous cleaning and degreasing of the three cavity walls, starting its grease oxidation phase when the oven reaches 200°C.

Buttons control

Easy and intuitive timer setting with a simple buttons

Drawer storage compartment

More space thanks to the lower drawer compartment, ideal for storing accessories or cooking utensils

True-convection

The best cooking performances guaranteed by ventilated circular flow

Multiple fans and heating elements guarantee the perfect aerodynamic heat flow, allowing homogeneous and quicker cooking inside the cavity.

Multilevel cooking

Several cooking levels allow maximum flexibility of use

Multilevel halogen light

Internal halogen lighting on different levels guarantees excellent visibility

Removable inner glass

Internal door glasses are easily removable for complete cleaning

Tangential cooling

New cooling system with tangential fan and airflow from the door to the splashback

Isothermic Cavity

The best cooking performance at the highest energy efficiency

BBQ (optional accessory)

Barbeque cooking directly in the oven with the double-sided grill (BBQ optional accessory)

Pizza stone (optional accessory)

Baking with refractory stone for soft and crispy pizza and yeast products (STONE optional accessory)

Cold door

During any function, the external door glass is cold, avoiding any risk of burns

AirFry (AIRFRY optional accessory)

Lighter and tastier food thanks to airfry basket (optional accessory)

Adjustable height

Cooker top flushed with the working area thanks to adjustable feet

Soft close

The door is equipped with a specific system for silent closing

Double Turbine

The oven has two fans equipped with two circular heating elements allowing cooking with rotating heat