

TR93GR

| | |
|--|-------------------|
| Cooker size | 90x60 cm |
| N.º de cavidades com rótulo energético | 2 |
| Fonte de calor da cavidade | ELECTRICITY |
| Hob type | Gas |
| Tipo de forno principal | Thermo-ventilated |
| Type of second oven | Thermo-ventilated |
| Sistema de limpeza no forno principal | Vapor Clean |
| EAN code | 8017709294243 |
| Energy efficiency class | A |
| Energy efficiency class, second cavity | B |



Aesthetics



| | | | |
|--------------------------------|--|--------------------------|-------------------------|
| Aesthetic Design | Victoria | Control knobs | Smeg Victoria |
| Colour | Victoria | Controls colour | Stainless steel |
| Acabamento | Cinza ardósia | No. of controls | 10 |
| Command panel finish | Brilhante | Cor da serigrafia | Serigrafia em prateado |
| Logo | Enamelled metal | Display | electronic 5 buttons |
| Posição do logotipo | Logotipo Anni 50 | Door | With frame |
| Upstand | Logotipo na zona da placa+ Logotipo no painel de comandos | Glass type | Black |
| Cor da placa | Yes | Handle | Smeg Victoria |
| Type of pan stands | Esmalte preto | Handle Colour | Brushed stainless steel |
| Type of control setting | Cast Iron | Plinth | Anthracite |
| | Control knobs | | |

Programs / Functions

No. of cooking functions 5
Traditional cooking functions

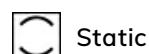

Static

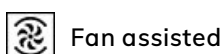

Fan assisted

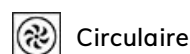

Circulaire



Eco



Fan assisted bottom

Other functions

 Defrost by time

Recipes No

Cleaning functions

 Vapor clean

Programs / Functions Auxiliary Oven

Funções de cozedura cavidade 2 1

Funções tradicionais de cozimento, cavidade 2

 Circulaire

Defrost No

Vapor Clean No

Programs / Functions Third Oven

No. of functions third oven 1

Oven light 

Half grill No

Full grill 

Hob technical features

UR

Total no. of cook zones 6

Front left - Gas - 2UR (dual) - 4.20 kW

Rear left - Gas - AUX - 1.00 kW

Front centre - Gas - AUX - 1.00 kW

Rear centre - Gas - Semi Rapid - 1.80 kW

Front right - Gas - Semi Rapid - 1.80 kW

Rear right - Gas - Rapid - 2.90 kW

Type of gas burners Standard

Gas safety valves Yes

Automatic electronic ignition Yes

Burner caps Matt black enamelled

Main Oven Technical Features



No. of lights 1

Removable inner door Yes

Fan number 1

Total no. of door glasses 3

Net volume of the cavity 61 l

| | | | |
|---------------------------------|-------------------|---|--------------------|
| Gross volume, 1st cavity | 70 l | No. of thermo-reflective door glasses | 1 |
| Cavity material | Ever Clean enamel | Safety Thermostat | Yes |
| No. of shelves | 4 | Cooling system | Tangential |
| Type of shelves | Metal racks | Usable cavity space dimensions (HxWxD) | 316x460x412 mm |
| Roof Liner | No | Temperature control | Electro-mechanical |
| Light type | Halogen | Lower heating element power | 1200 W |
| Light Power | 40 W | Upper heating element - Power | 1000 W |
| Cooking time setting | Start and Stop | Grill element | 1700 W |
| Door opening | Side opening | Large grill - Power | 2700 W |
| Removable door | Yes | Circular heating element - Power | 2000 W |
| Full glass inner door | Yes | Grill type | Electric |
| | | Tilting grill | Yes |

Options Main Oven

| | | | |
|--------------------------------------|-----|----------------------------|--------|
| Timer | Yes | Minimum Temperature | 50 °C |
| End of cooking acoustic alarm | Yes | Maximum temperature | 260 °C |

Second Oven Technical Features



| | | | |
|--|-------------------|---|--------------------|
| Net volume of the second cavity | 62 l | Full glass inner door | Yes |
| Gross volume, 2nd cavity | 69 l | Removable inner door | Yes |
| Cavity material | Ever Clean enamel | No. total door glasses | 2 |
| No. of shelves | 9 | No. thermo-reflective door glasses | 1 |
| Type of shelves | Metal racks | Safety Thermostat | Yes |
| Roof Liner | No | Cooling system | Tangential |
| No. of lights | 1 | Usable cavity space dimensions (HxWxD) | 605x275x370 mm |
| Light type | Halogen | Temperature control | Electro-mechanical |
| Light Power | 40 W | Potência da resistência circular | 2500 W |
| Door opening | Side opening | Tilting grill | No |
| Removable door | Yes | | |

Options Auxiliary Oven

| | | | |
|--------------------------------------|----|----------------------------|--------|
| Timer | No | Minimum Temperature | 50 °C |
| End of cooking acoustic alarm | No | Maximum temperature | 245 °C |

Third Oven Technical Features



| | | | |
|---------------------------------|-------------------|---|--------------------|
| Net volume, 3rd cavity | 36 l | Full glass inner door | Yes |
| Gross volume, 3rd cavity | 41 l | Removable inner door | Yes |
| Cavity material | Ever Clean enamel | No. total door glasses | 3 |
| No. of shelves | 2 | No. of thermo-reflective door glasses | 1 |
| Type of shelves | Metal racks | Safety Thermostat | Yes |
| Roof Liner | No | Cooling system | Tangential |
| No. of lights | 1 | Usable cavity space dimensions (HxWxD) | 169x440x443 mm |
| Light type | Halogen | Temperature control | Electro-mechanical |
| Light Power | 40 W | Large grill - Power | 2700 W |
| Door opening | Flap down | Grill type | Electric |
| Removable door | Yes | Tilting grill | Yes |

Options Third Oven

| | | | |
|--------------------------------------|----|----------------------------|--------|
| Timer | No | Minimum Temperature | 50 °C |
| End of cooking acoustic alarm | No | Maximum temperature | 260 °C |

Accessories included for Main Oven & Hob



| | | | |
|--|---|---|---|
| Cast iron wok support | 1 | 40mm deep tray | 1 |
| Moka stand in cast iron | 1 | Grill mesh | 1 |
| Rack com batente traseiro e lateral | 2 | Telescopic Guide rails, partial Extraction | 1 |

Accessories included for Secondary Oven



| | | | |
|---------------------------------|---|--------------------------|---|
| Oven grid with back stop | 3 | Plate rack/warmer | 1 |
|---------------------------------|---|--------------------------|---|

Accessories included for Third Oven

| | | | |
|--|---|-----------------------|---|
| Rack com batente traseiro e lateral | 1 | 40mm deep tray | 1 |
|--|---|-----------------------|---|

Electrical Connection

| | | | |
|-------------------------------------|--------|-------------------------------|-------------------------|
| Plug | No | Electric cable | Installed, Single phase |
| Electrical connection rating | 8300 W | Type of electric cable | Double and Three Phase |
| Current | 36 A | Frequency | 50/60 Hz |
| | | Bloco de terminais | 5 polos |

Voltage 220-240 V

Voltage 2 (V) 380-415 V

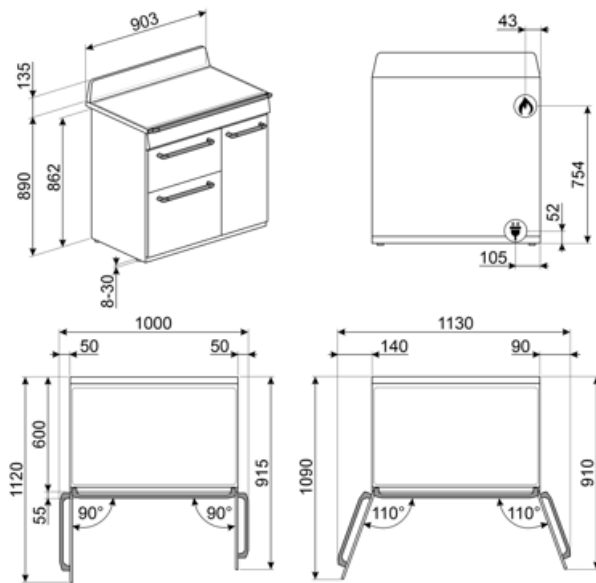

Compatible Accessories

AIRFRY

Air fryer rack AIRFRY . Ideal for recreating traditional frying in the oven, but with fewer calories and less fat. It allows you to cook quickly and simply dishes such as French fries, fried vegetables and fish, ensuring perfect browning and crispiness.



BGTR9

Placa para grelhar de ferro fundido adequada para fogões Victoria 90 cm, Master e Sinfonia de 60 e 90 cm



BN640

Tabuleiro esmaltado, 40mm de profundidade



GTP

** Guias telescópicas parcialmente extraíveis (1 nível)** Extração: 300 mm
Material: Aço inoxidável AISI 430 polido



KIT1TR9N

Painel anti-salpicos, 90x75 cm adequado para fogões Victoria TR9, preto



PALPZ

Pá para pizza com alça dobrável largura: 315mm comprimento : 325mm



SMOLD

Conjunto de 7 moldes de silicone para sorvetes, gelados, pralinés, cubos de gelo ou para porção de alimentos. Utilizável de -60°C a +230°C

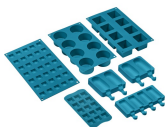

BBQ

Double sided plate BBQ. Suitable for recreating succulent and crispy dishes in the oven with the typical taste of grilled cooking. The ribbed side is particularly suitable for meats and cheeses. The smooth side for fish, seafood and vegetables.



BN620-1

Tabuleiro esmaltado, 20mm de profundidade



BNP608T

Bandeja revestida de teflon, 8mm de profundidade, a ser colocada na grade



GTT

** Guias telescópicas totalmente extraíveis (1 nível)** Extração: 433 mm
Material: Aço inoxidável AISI 430 polido



KITH93

Kit extensão de altura (950 mm), adequado para fogões TR93



SFLK1

Bloqueio para crianças



































STONE

Pedra refratária retangular Ideal para cozinhar pizzas com os mesmos resultados de um forno típico a lenha. Também pode ser usado para assar pães, focaccias e outras receitas como tortas, flans ou biscoitos
Dimensões:L42 x H1,8 x P37,5 cm.



Symbols glossary

| | | | |
|--|---|---|--|
|  | Suportes de ferro fundido para serviço pesado: para máxima estabilidade e resistência. |  | R: Desempenho de secagem do produto, medido de A++ a D/G, dependendo da família de produtos |
|  | Instalação em coluna: Instalação em coluna |  | Controle dos botões |
|  | Sistema de arrefecimento a ar: para garantir temperaturas de superfície seguras. |  | Descongela pelo tempo: com esta função, o tempo de descongelamento dos alimentos é determinado automaticamente. |
|  | B: Classificação de energia do produto, medida de A+++ a D/G, dependendo da família de produtos. |  | Portas de vidros duplos: Número de portas envidraçadas. |
|  | Portas envidraçadas triplas: Número de portas envidraçadas. |  | Interior esmaltado: O interior em esmalte de todos os fornos Smeg tem um revestimento antiácido especial que ajuda a manter o interior limpo, reduzindo a quantidade de gordura de cozimento aderente a ele. |
|  | Circogas: Em fornos a gás, o ventilador distribui o calor de forma rápida e uniforme por toda a cavidade do forno, evitando a transferência de sabor ao cozinhar vários pratos diferentes ao mesmo tempo. Em fornos elétricos, esta combinação completa o cozimento mais rapidamente de alimentos que estão prontos na superfície, mas que exigem mais cozimento no interior, sem mais escurecimento. |  | Ventilador com elementos superiores e inferiores: Os elementos combinados com o ventilador visam fornecer calor mais uniforme, um método semelhante ao cozimento convencional, de modo que o pré-aquecimento é necessário. Mais adequado para itens que exigem métodos de cozimento lento. |
|  | Somente elementos superior e inferior: um método de cozimento tradicional mais adequado para itens individuais localizados no centro do forno. A parte superior do forno será sempre mais quente. Ideal para assados, bolos de frutas, pão, etc. |  | Circulaire: A combinação do ventilador e do elemento circular em torno dele dá um método de cozimento de ar quente. Isso oferece muitos benefícios, incluindo nenhum pré-aquecimento se o tempo de cozimento for superior a 20 minutos, nenhuma transferência de sabor ao cozinhar alimentos diferentes ao mesmo tempo, menos energia e tempos de cozimento mais curtos. Bom para todos os tipos de alimentos. |
|  | ECO: A combinação da grelha, ventilador e elemento inferior é particularmente adequada para cozinhar pequenas quantidades de alimentos. |  | Elemento de grelha O uso de grelha dá excelentes resultados ao cozinhar carne de porções médias e pequenas, especialmente quando combinada com uma rotisseria (sempre que possível). Também é ideal para cozinhar salsichas e bacon. |
|  | Luz |  | Toda a porta interna de vidro: Toda a porta interna de vidro, uma única superfície plana que é simples de manter limpa. |
|  | O vidro interior da porta: pode ser removido com alguns movimentos rápidos para limpeza. |  | Luzes laterais: Duas luzes laterais opostas aumentam a visibilidade dentro do forno. |

-
- | | | | |
|--|---|---|---|
|  | Aquecimento: Uma opção para aquecer o prato e manter as refeições preparadas quentes. |  | O compartimento do forno tem 2 níveis de cozimento diferentes. |
|  | O compartimento do forno tem 4 níveis de cozimento diferentes. |  | O compartimento do forno tem 9 níveis de cozimento diferentes. |
|  | Trilhos telescópicos: permitem puxar o prato e verificá-lo sem ter que removê-lo completamente do forno. |  | Comando eletrônico. Permite manter a temperatura no interior do forno com a precisão de 2-3 ° C. Isso permite cozinhar refeições que são muito sensíveis a mudanças de temperatura, como por ex. bolos, suflês, pudins. |
|  | Grelha basculante: a grelha basculante pode ser facilmente desengatada para mover o elemento de aquecimento e limpar o tejadilho do aparelho em um simples passo. |  | Queimadores ultrarrápidos: Queimadores ultrarrápidos potentes oferecem até 5kw de potência. |
|  | Limpeza a Vapor: uma função de limpeza simples que utiliza vapor para afrouxar os depósitos no compartimento do forno. |  | A capacidade indica a quantidade de espaço útil no compartimento do forno em litros. |
|  | A capacidade indica a quantidade de espaço útil no compartimento do forno em litros. |  | A capacidade indica a quantidade de espaço útil no compartimento do forno em litros. |

Benefit (TT)

Gas hob

Gas provides permanent control of the heat source and the temperature change is immediate

Equipped with a thermocouple, the gas supply is cut off if the flame is extinguished for greater safety.

Vapor Clean

By inserting water into a recess at the bottom of the cavity, steam is generated, which softens the residue and facilitates its removal

By inserting water into a recess at the bottom of the cavity, steam is generated, which softens the residue and facilitates its removal.

Buttons control

Easy and intuitive timer setting with a simple buttons

True-convection

The best cooking performances guaranteed by ventilated circular flow

Multiple fans and heating elements guarantee the perfect aerodynamic heat flow, allowing homogeneous and quicker cooking inside the cavity.

Multilevel cooking

Several cooking levels allow maximum flexibility of use

Multilevel halogen light

Internal halogen lighting on different levels guarantees excellent visibility

Removable inner glass

Internal door glasses are easily removable for complete cleaning

Tangential cooling

New cooling system with tangential fan and airflow from the door to the splashback

Telescopic guides

Easy extraction and safe insertion of trays into the oven thanks to telescopic guides

Isothermic Cavity

The best cooking performance at the highest energy efficiency

BBQ (optional accessory)

Barbeque cooking directly in the oven with the double-sided grill (BBQ optional accessory)

Pizza stone (optional accessory)

Baking with refractory stone for soft and crispy pizza and yeast products (STONE optional accessory)

Adjustable height

Cooker top flushed with the working area thanks to adjustable feet

Cold door

During any function, the external door glass is cold, avoiding any risk of burns

AirFry (AIRFRY optional accessory)

Lighter and tastier food thanks to airfry basket (optional accessory)

Single turbine

The oven has a fan equipped with a circular heating element allowing cooking with rotating heat