

TR93IGR2

Categorie fornuis	90x60 cm
N. of cavities with energy label	2
Cavity heat source	Elektriciteit
Type kookplaat	Inductie
Type primaire oven	Thermogeventileerd
Type secundaire oven	Thermogeventileerd
Reinigingssysteem primaire oven	Vapor Clean reiniging
EAN-code	8017709312398
Energie-efficiëntieklasse	A
Energie-efficiëntieklasse, tweede oven	B



Design

			
Design	Victoria	Bedieningsknoppen	Smeg Victoria
Afwerking bedieningspaneel	Gekleurd plaatstaal	Kleur bedieningsknoppen	Inox
Design Logo	Victoria assembled 50's	Aantal bedieningsknoppen	9
Kleur	Leigrijs	Kleur serigrafie	Zwart
Positie logo	Upstand+ Bedieningspaneel	Display	Elektronisch 5 toetsen
Afwerking Upstand	Glanzend	Deur	Met kader
Kleur kookplaat	Ja	Type glas	Zwart
Bediening	Black enamel Bedieningsknoppen	Handgreep	Smeg Victoria
		Kleur handgreep	Geborsteld inox
		Plint	Antraciet

Programma's / Functies

Aantal kookfuncties	5
Traditionele bereidingsfuncties	



Statisch



Geventileerd



Circulatie (ventilator + circulaire)



ECO



Geventileerde onderwarmte

Overige functies

 Ontdooien op tijd

Reinigingsfuncties

 Vapor Clean reiniging

Programma's / Functies secundaire oven

Aantal kookfuncties 1

Traditionele bereidingsfuncties, 2e oven



Circulatie (ventilator + circulaire)

Programma's / Functies derde oven

Aantal functies derde oven 1

Licht 

Grote vlakgrill 

Technische specificaties kookplaat



Totaal aantal kookzones 5

Linksvoor - Inductie - enkel - 2.30 kW - Booster 3.00 kW - - Ø 21.0 cm

Linksachter - Inductie - enkel - 1.40 kW - - Ø 18.0 cm

Midden - Inductie - enkel - 2.30 kW - Booster 3.00 kW - - Ø 27.0 cm

Rechtsachter - Inductie - enkel - 1.40 kW - - Ø 18.0 cm

Rechtsvoor - Inductie - enkel - 2.30 kW - Booster 3.00 kW - - Ø 21.0 cm

Automatisch uitschakelen i.g.v. oververhitting Ja Indicator minimaal te gebruiken diameter Ja

Automatische aanpassing panafmeting Ja Indicator geselecteerde zone Ja

Technische specificaties primaire oven



Aantal lampen	1	Uitneembaar glas binnendeur	Ja
Aantal ventilatoren	1	Aantal ruiten ovendeur	3
Netto volume 1e oven	61 l	Aantal thermo-reflecterende ruiten	1
Bruto volume, oven 1	70 l		

Materiaal ovenruimte	Ever Clean emaille	Veiligheidsthermostaat	Ja
Aantal kookniveaus	4	Afmetingen bruikbare interne ovenruimte (hxbxd)	316x460x412 mm
Type ovenrekken	Metalen zijsteunen	Temperatuurregeling	Elektro-mechanisch
Type licht	Halogeen	Onderwarmte - vermogen	1200 W
Vermogen lamp	40 W	Bovenwarmte - vermogen	1000 W
Opties bereidingstijdprogrammering	Begin en eind	Grill - vermogen	1700 W
Opening deur	Side opening	Grote vlakgrill - vermogen	2700 W
Uitneembare ovendeur	Ja	Circulatie - vermogen	2000 W
Volledig glazen binnendeur	Ja	Grill type	Elektrisch
		Kantelbare grill	Ja

Opties primaire oven

Timer	Ja	Minimum temperatuur	50 °C
Geluidssignaal einde kooktijd	Ja	Maximum temperatuur	245 °C

Technische specificaties secundaire oven



Aantal ventilatoren	1	Uitneembare ovendeur	Ja
Netto volume 2e oven	62 l	Volledig glazen binnendeur	Ja
Bruto volume, oven 2	69 l	Uitneembaar glas binnendeur	Ja
Materiaal ovenruimte	Ever Clean emaille	Aantal ruiten ovendeur	1
Aantal kookniveaus	9	Aantal thermo-reflecterende ruiten	1
Type ovenrekken	Metalen zijsteunen	Veiligheidsthermostaat	Ja
Aantal lampen	1	Koelsysteem	Mantelkoeling
Type lamp	Halogeen	Afmetingen bruikbare interne ovenruimte (hxbxd)	605x275x370 mm
Vermogen lamp	40 W	Temperatuurregeling	Elektro-mechanisch
Opening deur	Side opening	Circulatie - vermogen	2500 W

Opties secundaire oven

Minimum temperatuur	50 °C	Maximum temperatuur	245 °C
---------------------	-------	---------------------	--------

Technische specificaties derde oven



Netto volume, 3e oven	36 l
-----------------------	------

Bruto volume, oven 3	41 l	Uitneembaar glas binnendeur	Ja
Materiaal ovenruimte	Ever Clean emaille	Aantal ruiten ovendeur	3
Aantal kookniveaus	2	Aantal thermo-reflecterende ruiten	1
Type ovenrekken	Metalen zijsteunen	Veiligheidsthermostaat	Ja
Aantal lampen	1	Koelsysteem	Mantelkoeling
Type lamp	Halogeen	Afmetingen bruikbare interne ovenruimte (hxbxd)	169x440x443 mm
Vermogen lamp	40 W	Temperatuurregeling	Elektro-mechanisch
Opening deur	Neerwaarts	Grote vlakgrill - vermogen	2700 W
Uitneembare ovendeur	Ja	Type grill	Elektrisch
Volledig glazen binnendeur	Ja	Kantelbare grill	Ja

Opties derde oven

Minimum temperatuur	50 °C	Maximum temperatuur	260 °C
---------------------	-------	---------------------	--------

Meegeleverde accessoires primaire oven en kookplaat



Ovenrooster met stop	2	Inzetrooster	1
Bakplaat (40 mm)	1	Telescopische geleiders, gedeeltelijk uitschuifbaar	1

Meegeleverde accessoires secundaire oven



Ovenrooster met stop	3	Bordenwarmhouder	1
----------------------	---	------------------	---

Meegeleverde accessoires derde oven

Ovenrooster met stop	1	Bakplaat (40 mm)	1
----------------------	---	------------------	---

Elektrische aansluiting

Nominale aansluitwaarde	15000 W	Lengte voedingskabel	150 cm
Stroom	42 A	Type stroomkabel	Double and Three Phase
Spanning	220-240 V	Frequentie	50 Hz
Spanning 2 (V)	380-415 V	Connection box	5 polig
Electric cable	Installed, Single phase		



Compatible Accessories



BN620-1

Enamelled tray suitable for 45 cm and 60 cm ovens. Depth 20 mm. Perfect for a wide range of savoury and sweet baking.



BNP608T

Teflon bakplaat, 8mm diep



GTP

Partially extractable telescopic guides (1 level), suitable for traditional ovens. Made in stainless steel, they guarantee stability and facilitate the smooth extraction of the trays.



KIT1TR9N

Splashback black, 90cm, suitable for TR90 and TR93 Victoria cookers



KITH93

Height extension kit (950mm), black, suitable for TR93 cookers (945-960mm)



PALPZ

Pizzapallet inox met ploibaar handvat, 315x325 mm



SFLK1

Child lock



BN640

Enamelled tray suitable for 45cm and 60cm ovens. Depth 540 mm. Perfect for cooking and roasting meat and fish in sauces. Also ideal for experimenting with lighter and crunchy side dishes



GRILLPLATE

Universal griddle for induction, gas, ceramic and electric hobs. Non-stick surface ideal for cooking meat, cheese and vegetables. Dimensions: 410 x 240 mm.



GTT

Volledig uitschuifbare telescopische rails (1 niveau) voor traditionele ovens (SF-).



KIT600TR93

Cover strip for hob back side, suitable for TR93 Victoria cookers



KITP65TR93

Depth extension kit (650 mm), nero, suitable for TR93 cookers



SCRIP

Schraper voor inductie- en vitrokeramische kookplaten

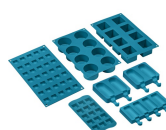

SMOLD

Set van 7 siliconen vormen voor ijsjes, pralines, ijsblokjes of porties. -60°C tot 230°C.

STONE

Rectangular refractory stone Ideal for cooking pizzas with the same results as a typical wood-fired oven. Can also be used for baking bread, focaccias and other recipes such as pies, flans or biscuits Dimensions: L42 x H1,8 x P37,5 cm.



































TPKPLATE

Universal plate for induction, gas, ceramic and electric hobs. Non-stick surface ideal for cooking fish, eggs and vegetables. Dimensions: 410 X 240 mm.



Symbols glossary

 <p>Sommige modellen zijn voorzien van een functie om het programma/de cyclus te blokkeren zodat het niet per ongeluk kan aangepast worden.</p>	 <p>Energy efficiency class A</p>
 <p>Installation in column: Installation in column.</p>	 <p>Air cooling system: to ensure a safe surface temperatures.</p>
 <p>B: Product energy rating, measured from A+++ to D / G depending on the product family.</p>	 <p>Defrost by time: Manual defrost function. At the end of the set duration, the function stops.</p>
 <p>Triple glazed doors: Number of glazed doors.</p>	 <p>ECO-logic: option allows you to restrict the power limit of the appliance real energy saving.</p>
 <p>Ever Clean Enamel: Ever Clean enamel is applied electrostatically, corner to corner and edge to edge to prevent cracking or cracks over time. It is a particular pyrolytic enamel, resistant to acids which, in addition to being pleasantly bright, promotes greater cleaning of the oven walls, thanks to its lower porosity. It is baked at over 850 °C and slowly polymerized at a scientifically determined rate to ensure uniform depth and strength. Ever Clean enamel creates an impeccable finish both on the inside of the oven and on the trays, making the surfaces of the oven incredibly easy to maintain over time as it reduces the adhesion of fat during cooking.</p>	 <p>Circogas: In gasovens verdeelt de ventilator de warmte snel en gelijkmatig over de ovenruimte, waardoor smaakoverdracht wordt vermeden bij het tegelijkertijd bereiden van een aantal verschillende gerechten. In elektrische ovens voltooit deze combinatie het koken van voedsel dat aan de oppervlakte klaar is, maar dat van binnen meer moet worden gekookt, zonder verder bruin te worden.</p>
 <p>Ventilator met bovenste en onderste elementen: De elementen in combinatie met de ventilator zijn bedoeld om een meer gelijkmatige warmte te bieden, een methode die vergelijkbaar is met conventioneel koken, dus voorverwarmen is vereist. Het meest geschikt voor items die langzaam koken vereisen.</p>	 <p>Alleen boven- en onder element: een traditionele kookmethode die het meest geschikt is voor losse items in het midden van de oven. de bovenkant van de oven zal altijd het heetst zijn. Ideaal voor gebraden vlees, fruitcake, brood etc.</p>
 <p>Circulaire: De combinatie van de ventilator en het ronde element eromheen zorgt voor een hete lucht kookmethode. Dit biedt vele voordelen, waaronder geen voorverwarmen als de kooktijd meer dan 20 minuten bedraagt, geen smaakoverdracht bij het gelijktijdig bereiden van verschillende soorten voedsel, minder energie en kortere kooktijden. Geschikt voor alle soorten voedsel.</p>	 <p>De combinatie van de grill, de ventilator en onderwarmte is interessant voor het bereiden van kleine hoeveelheden.</p>
 <p>Grill element: Using of grill gives excellent results when cooking meat of medium and small portions, especially when combined with a rotisserie (where possible). Also ideal for cooking sausages and bacon.</p>	 <p>Light</p>
 <p>Overheat protection: The safety system that automatically turns off the hob in case of overheating of the control unit.</p>	 <p>Induction: The work of these hobs is based on the principle of electromagnetic induction. The heat is generated directly in the bottom of the pan during its contact with the hob.</p>

-
-  All glass inner door: All glass inner door, a single flat surface which is simple to keep clean.
 -  Side lights: Two opposing side lights increase visibility inside the oven.
 -  The oven cavity has 2 different cooking levels.
 -  The oven cavity has 9 different cooking levels.
 -  Electronic control: Allows you to maintain temperature inside the oven with the precision 2-3 ° C. This enables to cook meals that are very sensitive to temperature changes, such as cakes, souffles, puddings.
 -  Vapor Clean: a simple cleaning function using steam to loosen deposits in the oven cavity.
 -  The capacity indicates the amount of usable space in the oven cavity in litres.
 -  Knobs control
 -  The inner door glass: can be removed with a few quick movements for cleaning.
 -  Plate rack warming: function for heating or keeping dishes warm. Place the baking tray on the lowest shelf and stack the dishes to be heated.
 -  The oven cavity has 4 different cooking levels.
 -  Telescopic rails: allow you to pull out the dish and check it without having to remove it from the oven entirely.
 -  Tilting grill: the tilting grill can be easily unhooked to move the heating element and clean the roof of the appliance in one simple step.
 -  The capacity indicates the amount of usable space in the oven cavity in litres.
 -  The capacity indicates the amount of usable space in the oven cavity in litres.

Benefit (TT)

Induction hob

Induction offers fast cooking and precise temperature control

Through the use of suitable cookware, induction is easy to use and maintain, safe and responsive.

Vapor Clean

By inserting water into a recess at the bottom of the cavity, steam is generated, which softens the residue and facilitates its removal

By inserting water into a recess at the bottom of the cavity, steam is generated, which softens the residue and facilitates its removal.

Buttons control

Easy and intuitive timer setting with a simple buttons

True-convection

The best cooking performances guaranteed by ventilated circular flow

Multiple fans and heating elements guarantee the perfect aerodynamic heat flow, allowing homogeneous and quicker cooking inside the cavity.

Multilevel cooking

Several cooking levels allow maximum flexibility of use

Multilevel halogen light

Internal halogen lighting on different levels guarantees excellent visibility

Removable inner glass

Internal door glasses are easily removable for complete cleaning

Telescopic guides

Easy extraction and safe insertion of trays into the oven thanks to telescopic guides

Adjustable height

Cooker top flushed with the working area thanks to adjustable feet

Isothermic Cavity

The best cooking performance at the highest energy efficiency

Cold door

During any function, the external door glass is cold, avoiding any risk of burns

AirFry (AIRFRY optional accessory)

Lighter and tastier food thanks to airfry basket (optional accessory)

BBQ (optional accessory)

Barbecue cooking directly in the oven with the double-sided grill (BBQ optional accessory)

Pizza stone (optional accessory)

Baking with refractory stone for soft and crispy pizza and yeast products (STONE optional accessory)

Single turbine

The oven has a fan equipped with a circular heating element allowing cooking with rotating heat