

# TR93IGR2

|  |                    |
|--|--------------------|
| Categorie fornuis                      | 90x60 cm           |
| Aantal ovens met energielabel          | 2                  |
| Cavity heat source                     | Elektrisch         |
| Type kookplaat                         | Inductie           |
| Type primaire oven                     | Thermogeventileerd |
| Type secundaire oven                   | Thermogeventileerd |
| Reinigingssysteem primaire oven        | Vapor Clean        |
| EAN-code                               | 8017709312398      |
| Energie-efficiëntieklasse              | A                  |
| Energie-efficiëntieklasse, tweede oven | B                  |



## Design



|                                   |                              |                                 |                           |
|-----------------------------------|------------------------------|---------------------------------|---------------------------|
| <b>Esthetiek</b>                  | Victoria                     | <b>Bedieningsknoppen</b>        | Smeg Victoria             |
| <b>Design</b>                     | Victoria                     | <b>Kleur knoppen</b>            | Roestvrij staal           |
| <b>Kleur</b>                      | Lei Grijs                    | <b>Aantal bedieningsknoppen</b> | 9                         |
| <b>Afwerking</b>                  | Glanzend                     | <b>Kleur serigrafie</b>         | Zwart                     |
| <b>Afwerking bedieningspaneel</b> | Gekleurd plaatstaal          | <b>Display</b>                  | Elektronisch 5 toetsen    |
| <b>Logo</b>                       | assembled 50's               | <b>Deur</b>                     | Met kader                 |
| <b>Positie logo</b>               | Upstand+<br>Bedieningspaneel | <b>Type glas</b>                | Zwart                     |
| <b>Upstand</b>                    | Ja                           | <b>Handgreep</b>                | Smeg Victoria             |
| <b>Kleur kookplaat</b>            | Zwart glanzend               | <b>Kleur handgreep</b>          | Geborsteld roestvrijstaal |
| <b>Type bediening</b>             | Bedieningsknoppen            | <b>Plint</b>                    | Antraciet                 |

## Programma's / functies

Aantal kookfuncties 5

Traditionele kookfuncties



Statisch



Geventileerd



Circulaire



ECO



Fan assisted base

Overige functies



Ontdooien op tijd

## Schoonmaak functie





## Programma's / functies secundaire oven

Kookfuncties ovenruimte 2 1  
 Traditionele kookfuncties, ovenruimte 2



## Programma's / functies derde oven

Aantal functies derde oven 1  
 Licht   
 Grote vlakgrill 

## Technische specificaties kookplaat



Totaal aantal kookzones 5

Linksvoor - Inductie - enkel - 2.30 kW - Booster 3.00 kW - - Ø 21.0 cm

Linksachter - Inductie - enkel - 1.40 kW - - Ø 18.0 cm

Midden - Inductie - enkel - 2.30 kW - Booster 3.00 kW - - Ø 27.0 cm

Rechtsachter - Inductie - enkel - 1.40 kW - - Ø 18.0 cm

Rechtsvoor - Inductie - enkel - 2.30 kW - Booster 3.00 kW - - Ø 21.0 cm

Automatische stop bij oververhitting Ja Indicator minimaal te gebruiken diameter Ja

Automatische aanpassing panafmeting Ja Indicator geselecteerde zone Ja

## Technische specificaties primaire oven



|                      |                    |   |                    |
|----------------------|--------------------|---|--------------------|
| Aantal lampen        | 1                  | Uitneembaar glas binnendeur                     | Ja                 |
| Aantal ventilatoren  | 1                  | Aantal ruiten ovendeur                          | 3                  |
| Netto inhoud         | 61 l               | Aantal thermo-reflecterende ruiten              | 1                  |
| Bruto inhoud 1e oven | 70 l               | Veiligheidsthermostaat                          | Ja                 |
| Materiaal ovenruimte | Ever Clean emaille | Afmetingen bruikbare interne ovenruimte (hxbxd) | 316x460x412 mm     |
| Aantal kookniveaus   | 4                  | Temperatuurregeling                             | Elektro-mechanisch |
| Type ovenrekken      | Metalen zijsteunen |   |                    |
| Soort verlichting    | Halogeen           |   |                    |
| Vermogen lamp        | 40 W               |   |                    |
| Instelling kooktijd  | Start en stop      |   |                    |

|                            |              |                            |            |
|----------------------------|--------------|----------------------------|------------|
| Deur openen                | Side opening | Onderwarmte - vermogen     | 1200 W     |
| Uitneembare ovendeur       | Ja           | Bovenwarmte - vermogen     | 1000 W     |
| Volledig glazen binnendeur | Ja           | Grill - vermogen           | 1700 W     |
|                            |              | Grote vlakgrill - vermogen | 2700 W     |
|                            |              | Circulatie - vermogen      | 2000 W     |
|                            |              | Type grill                 | Elektrisch |
|                            |              | Kantelbare grill           | Ja         |

## Opties primaire oven

|                                   |    |                     |        |
|-----------------------------------|----|---------------------|--------|
| Timer                             | Ja | Minimum temperatuur | 50 °C  |
| Akoestisch signaal einde kooktijd | Ja | Maximum temperatuur | 245 °C |

## Technische specificaties secundaire oven

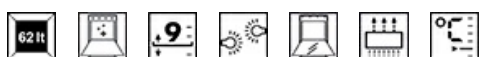

|                         |                    |   |                    |
|-------------------------|--------------------|---|--------------------|
| Aantal ventilatoren     | 1                  | Uitneembare ovendeur                            | Ja                 |
| Netto inhoud (l) oven 2 | 62 l               | Volledig glazen binnendeur                      | Ja                 |
| Bruto inhoud, 2e oven   | 69 l               | Uitneembaar glas binnendeur                     | Ja                 |
| Materiaal ovenruimte    | Ever Clean emaille | Aantal ruiten ovendeur                          | 1                  |
| Aantal kookniveaus      | 9                  | Aantal thermo-reflecterende ruiten              | 1                  |
| Type ovenrekken         | Metalen zijsteunen | Veiligheidsthermostaat                          | Ja                 |
| Aantal lampen           | 1                  | Koelsysteem                                     | Mantelkoeling      |
| Soort verlichting       | Halogeen           | Afmetingen bruikbare interne ovenruimte (hxbxd) | 605x275x370 mm     |
| Vermogen lamp           | 40 W               | Temperatuurregeling                             | Elektro-mechanisch |
| Deur openen             | Side opening       | Circulatie - vermogen                           | 2500 W             |

## Opties secundaire oven

|                     |       |                     |        |
|---------------------|-------|---------------------|--------|
| Minimum temperatuur | 50 °C | Maximum temperatuur | 245 °C |
|---------------------|-------|---------------------|--------|

## Technische specificaties derde oven



|                         |                    |                                    |    |
|-------------------------|--------------------|------------------------------------|----|
| Netto inhoud (l) oven 3 | 36 l               | Uitneembaar glas binnendeur        | Ja |
| Bruto inhoud, 3e oven   | 41 l               | Aantal ruiten ovendeur             | 3  |
| Materiaal ovenruimte    | Ever Clean emaille | Aantal thermo-reflecterende ruiten | 1  |
| Aantal kookniveaus      | 2                  |                                    |    |

|                            |                    |   |                    |
|----------------------------|--------------------|---|--------------------|
| Type ovenrekken            | Metalen zijsteunen | Veiligheidsthermostaat                          | Ja                 |
| Aantal lampen              | 1                  | Koelsysteem                                     | Mantelkoeling      |
| Soort verlichting          | Halogeen           | Afmetingen bruikbare interne ovenruimte (hxbxd) | 169x440x443 mm     |
| Vermogen lamp              | 40 W               | Temperatuurregeling                             | Elektro-mechanisch |
| Deur openen                | naar beneden       | Grote vlakgrill - vermogen                      | 2700 W             |
| Uitneembare ovendeur       | Ja                 | Type grill                                      | Elektrisch         |
| Volledig glazen binnendeur | Ja                 | Kantelbare grill                                | Ja                 |

## Opties derde oven

|                     |       |                     |        |
|---------------------|-------|---------------------|--------|
| Minimum temperatuur | 50 °C | Maximum temperatuur | 260 °C |
|---------------------|-------|---------------------|--------|

## Meegeleverde accessoires primaire oven en kookplaat



|                            |   |   |   |
|----------------------------|---|---|---|
| Rek met achter- en zijstop | 2 | Inzetrooster  | 1 |
| Bakplaat (40 mm)           | 1 | Telescopische geleiders, gedeeltelijk uitschuifbaar | 1 |

## Meegeleverde accessoires secundaire oven



|                      |   |                  |   |
|----------------------|---|------------------|---|
| Ovenrooster met stop | 3 | Bordenwarmhouder | 1 |
|----------------------|---|------------------|---|

## Meegeleverde accessoires derde oven

|                            |   |                  |   |
|----------------------------|---|------------------|---|
| Rek met achter- en zijstop | 1 | Bakplaat (40 mm) | 1 |
|----------------------------|---|------------------|---|

## Elektrische aansluiting

|                |                         |                      |                        |
|----------------|-------------------------|----------------------|------------------------|
| Aansluitwaarde | 15000 W                 | Lengte voedingskabel | 150 cm                 |
| Stroom         | 42 A                    | Type stroomkabel     | Double and Three Phase |
| Spanning       | 220-240 V               | Frequentie           | 50 Hz                  |
| Spanning 2 (V) | 380-415 V               | Aansluitkast         | 5 polig                |
| Electric cable | Installed, Single phase |                      |                        |

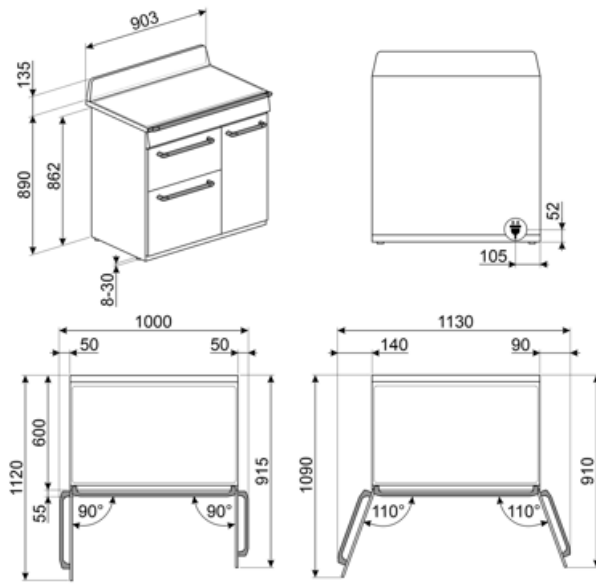

## Accessoires niet inbegrepen

### KIT600TR93

Cover strip for hob back side, suitable for TR93 Victoria cookers



### SFLK1

Kinderslot



### PRTX

Ronde pizzasteen met handvaten, diameter 35 cm



### GRILLPLATE

Universal griddle for induction, gas, ceramic and electric hobs. Non-stick surface ideal for cooking meat, cheese and vegetables. Dimensions: 410 x 240 mm.



### BN620-1

Geëmailleerde bakplaat, 20 mm diep



### KITH93

Height extension kit (950mm), black, suitable for TR93 cookers (945-960mm)



### TPKPLATE

Universal plate for induction, gas, ceramic and electric hobs. Non-stick surface ideal for cooking fish, eggs and vegetables. Dimensions: 410 X 240 mm.



### GTT

Volledig uittrekbare telescopische geleiders (1 niveau)



### SMOLD

Set van 7 siliconen vormpjes voor ijsjes, ijslolly's, pralines, ijsblokjes of om etenswaren te portioneren. Bruikbaar van -60 ° C tot + 230 ° C

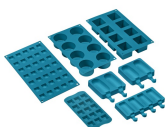

### KITP65TR93

Depth extension kit (650 mm), nero, suitable for TR93 cookers



### GTP

Gedeeltelijk uittrekbare telescopische geleiders (1 niveau)



### BNP608T

Teflon-coated tray, 8mm depth, to be placed on the grid



### KIT1TR9N

Splashback black, 90cm ,suitable for TR90 and TR93 Victoria cookers



### SCRP

Inductie- en keramische kookplaten en teppanyaki-schraper



### STONE

Rectangular refractory stone Ideal for cooking pizzas with the same results as a typical wood-fired oven. Can also be used for baking bread, focaccias and other recipes such as pies, flans or biscuits Dimensions:L42 x H1,8 x P37,5 cm.



### PALPZ

Pizzaschep met inklapbare handgreep breedte: 315 mm lengte: 325 mm







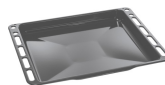



























### BN640

Geëmailleerde bakplaat, 40 mm diep



## Symbols glossary (TT)

|  |  |
|--|--|
|  <p>A: Droogprestaties van het product, gemeten vanaf A +++ tot D / G afhankelijk van de productfamilie</p>  |  <p>B: Energieklasse van het product, gemeten van A +++ tot D / G, afhankelijk van de productfamilie.</p>   |
|  <p>Kinderslot: sommige modellen zijn voorzien van een apparaat om het programma / de cyclus te vergrendelen zodat het niet kan per ongeluk veranderd</p>  |  <p>Installation in column: Installation in column</p>  |
|  <p>Luchtkoelsysteem: om een veilig oppervlak te garanderen temperaturen.</p>  |  <p>Ontdooien op tijd: met deze functie wordt automatisch het tijdstip van ontdooien van voedsel bepaald</p>  |
|  <p>Deuren met driedubbele beglazing: aantal glazen deuren.</p>  |  <p>ECO-logic: optie stelt u in staat om de vermogenslimiet van de werkelijke energiebesparing van het apparaat te beperken</p>   |
|  <p>Geëmailleerde binnenkant: De geëmailleerde binnenkant van alle Smeg-ovens heeft een speciale antacidumvoering die helpt om de binnenkant schoon te houden door de hoeveelheid kookvet te verminderen.</p>  |  <p>Fan assisted base: the mix of fan and lower heating element alone allows to finish cooking foods already cooked on the surface but not internally more quickly. This system is recommended to finish cooking foods that are already well cooked on the surface, but not internally, which therefore require a moderate higher heat. Ideal for any type of food.</p>   |
|  <p>Ventilator met bovenste en onderste elementen: de elementen in combinatie met de ventilator zijn bedoeld om een meer gelijkmatige warmte te bieden, een methode die vergelijkbaar is met conventioneel koken, dus voorverwarmen is vereist. Het meest geschikt voor items die langzaam koken vereisen.</p>   |  <p>De ovenruimte wordt tegelijk door het onder- en bovenelement verwarmt. De hitteverdeling over het gerecht is afhankelijk van het niveau waarop men dit plaatst. Geschikt voor bakken op 1 niveau. Gerechten: alle ovenschotels, vlees, gevogelte, brood, (gevulde) taarten. Speciaal: gans en eend (bevatten veel vet).</p>   |
|  <p>Circulaire: it is the perfect function for cooking all types of dishes in a more delicate way. The heat comes from the back of the oven and is distributed quickly and evenly The fan is active. It is also ideal for cooking on multiple levels without mixing smells and flavors.</p>  |  <p>ECO: low energy consumption cooking: this function is particularly suitable for cooking on a single shelf with low energy consumption. It is recommended for all types of food except those that can generate a lot of moisture (for example vegetables). To achieve maximum energy savings and reduce time, it is recommended to put the food in the oven without preheating the cooking compartment</p> |
|  <p>De warmte wordt geproduceerd door het grill- en bovenelement. Verhitting over het volledige oppervlak. De thermostaat wordt, afhankelijk van het gerecht, in de regel op de maximale stand gezet. Bij een korte baktijd kan de ovendeur gesloten blijven; bij langere baktijd blijft deze gedeeltelijk geopend. Voor vleesgerechten (klein- en middelgroot), vleespennen, vis, groenten, gratineren etc.</p> |  <p>Light</p>   |

-  Overheat protection: The safety system that automatically turns off the hob in case of overheating of the control unit.
-  All glass inner door: All glass inner door, a single flat surface which is simple to keep clean.
-  verlichting
-  The oven cavity has 2 different cooking levels.
-  The oven cavity has 9 different cooking levels.
-  Electronic control: Allows you to maintain temperature inside the oven with the precision 2-3 ° C. This enables to cook meals that are very sensitive to temperature changes, such as cakes, souffles, puddings.
-  Vapor Clean: a simple cleaning function using steam to loosen deposits in the oven cavity.
-  The capacity indicates the amount of usable space in the oven cavity in litres.
-  Knobs control
-  Induction: The work of these hobs is based on the principle of electromagnetic induction. The heat is generated directly in the bottom of the pan during its contact with the hob.
-  The inner door glass: can be removed with a few quick movements for cleaning.
-  Plate rack warming: function for heating or keeping dishes warm. Place the baking tray on the lowest shelf and stack the dishes to be heated.
-  The oven cavity has 4 different cooking levels.
-  Telescopic rails: allow you to pull out the dish and check it without having to remove it from the oven entirely.
-  Tilting grill: the tilting grill can be easily unhooked to move the heating element and clean the roof of the appliance in one simple step.
-  The capacity indicates the amount of usable space in the oven cavity in litres.
-  The capacity indicates the amount of usable space in the oven cavity in litres.



## Benefit (TT)

---

### **True-convection**

The best cooking performances guaranteed by ventilated circular flow

Multiple fans and heating elements guarantee the perfect aerodynamic heat flow, allowing homogeneous and quicker cooking inside the cavity.

### **Induction hob**

Induction offers fast cooking and precise temperature control

Through the use of suitable cookware, induction is easy to use and maintain, safe and responsive.

### **Vapor Clean**

By inserting water into a recess at the bottom of the cavity, steam is generated, which softens the residue and facilitates its removal

By inserting water into a recess at the bottom of the cavity, steam is generated, which softens the residue and facilitates its removal.

### **Single turbine**

The oven has a fan equipped with a circular heating element allowing cooking with rotating heat

### **Isothermic Cavity**

The best cooking performance at the highest energy efficiency

### **Multilevel halogen light**

Internal halogen lighting on different levels guarantees excellent visibility

### **Buttons control**

Easy and intuitive timer setting with a simple buttons

### **Telescopic guides**

Easy extraction and safe insertion of trays into the oven thanks to telescopic guides

### **Adjustable height**

Cooker top flushed with the working area thanks to adjustable feet

### **Removable inner glass**

Internal door glasses are easily removable for complete cleaning

### **Multilevel cooking**

Several cooking levels allow maximum flexibility of use

**Cold door**

During any function, the external door glass is cold, avoiding any risk of burns

**AirFry (AIRFRY optional accessory)**

Lighter and tastier food thanks to airfry basket (optional accessory)

**BBQ (optional accessory)**

Barbeque cooking directly in the oven with the double-sided grill (BBQ optional accessory)

**Pizza stone (optional accessory)**

Baking with refractory stone for soft and crispy pizza and yeast products (STONE optional accessory)