

TR93IP2

Categorie fornuis	90x60 cm
Aantal ovens met energielabel	2
Cavity heat source	Elektrisch
Type kookplaat	Inductie
Type primaire oven	Thermogeventileerd
Type secundaire oven	Thermogeventileerd
Reinigingssysteem primaire oven	Vapor Clean
EAN-code	8017709312381
Energie-efficiëntieklasse	A
Energie-efficiëntieklasse, tweede oven	B



Design



Design	Victoria	Bedieningsknoppen	Smeg Victoria
Afwerking bedieningspaneel	Gekleurd plaatstaal	Kleur knoppen	Roestvrij staal
Esthetiek	Victoria	Aantal bedieningsknoppen	9
Logo	assembled 50's	Kleur serigrafie	Zwart
Kleur	Crème	Display	Elektronisch 5 toetsen
Positie logo	Upstand+ Bedieningspaneel	Deur	Met kader
Afwerking	Glanzend	Type glas	Zwart
Upstand	Ja	Handgreep	Smeg Victoria
Kleur kookplaat	Zwart glanzend	Kleur handgreep	Geborsteld roestvrijstaal
Type bediening	Bedieningsknoppen	Plint	Antraciet

Programma's / functies

Aantal kookfuncties 5

Traditionele kookfuncties

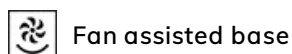

Overige functies



Schoonmaak functie



Programma's / functies secundaire oven

Kookfuncties ovenruimte 2 1
 Traditionele kookfuncties, ovenruimte 2



Programma's / functies derde oven

Aantal functies derde oven 1
 Licht 
 Grote vlakgrill 

Technische specificaties kookplaat



Totaal aantal kookzones 5

Linksvoor - Inductie - enkel - 2.30 kW - Booster 3.00 kW - - Ø 21.0 cm

Linksachter - Inductie - enkel - 1.40 kW - - Ø 18.0 cm

Midden - Inductie - enkel - 2.30 kW - Booster 3.00 kW - - Ø 27.0 cm

Rechtsachter - Inductie - enkel - 1.40 kW - - Ø 18.0 cm

Rechtsvoor - Inductie - enkel - 2.30 kW - Booster 3.00 kW - - Ø 21.0 cm

Automatische stop bij oververhitting Ja Indicator minimaal te gebruiken diameter Ja

Automatische aanpassing panafmeting Ja Indicator geselecteerde zone Ja

Technische specificaties primaire oven



Aantal lampen	1	Aantal ruiten ovendeur	3
Aantal ventilatoren	1	Aantal thermo-reflecterende ruiten	1
Netto inhoud	61 l	Veiligheidsthermostaat	Ja
Bruto inhoud 1e oven	70 l	Koelsysteem	Mantelkoeling
Materiaal ovenruimte	Ever Clean emaille	Afmetingen bruikbare interne ovenruimte (hxbxd)	316x460x412 mm
Aantal kookniveaus	4	Temperatuurregeling	Elektro-mechanisch
Type ovenrekken	Metalen zijsteunen		
Soort verlichting	Halogeen		
Vermogen lamp	40 W		
Instelling kooktijd	Start en stop		

Deur openen	Side opening	Onderwarmte - vermogen	1200 W
Uitneembare ovendeur	Ja	Bovenwarmte - vermogen	1000 W
Volledig glazen binnendeur	Ja	Grill - vermogen	1700 W
Uitneembaar glas binnendeur	Ja	Grote vlakgrill - vermogen	2700 W
		Circulatie - vermogen	2000 W
		Type grill	Elektrisch
		Kantelbare grill	Ja

Opties primaire oven

Timer	Ja	Minimum temperatuur	50 °C
Akoestisch signaal einde kooktijd	Ja	Maximum temperatuur	245 °C

Technische specificaties secundaire oven



Aantal ventilatoren	1	Uitneembare ovendeur	Ja
Netto inhoud (l) oven 2	62 l	Volledig glazen binnendeur	Ja
Bruto inhoud, 2e oven	69 l	Uitneembaar glas binnendeur	Ja
Materiaal ovenruimte	Ever Clean emaille	Aantal ruiten ovendeur	1
Aantal kookniveaus	9	Aantal thermo-reflecterende ruiten	1
Type ovenrekken	Metalen zijsteunen	Veiligheidsthermostaat	Ja
Aantal lampen	1	Koelsysteem	Mantelkoeling
Soort verlichting	Halogeen	Afmetingen bruikbare interne ovenruimte (hxbxd)	605x275x370 mm
Vermogen lamp	40 W	Temperatuurregeling	Elektro-mechanisch
Deur openen	Side opening	Circulatie - vermogen	2500 W

Opties secundaire oven

Minimum temperatuur	50 °C	Maximum temperatuur	245 °C
---------------------	-------	---------------------	--------

Technische specificaties derde oven



Netto inhoud (l) oven 3	36 l	Uitneembaar glas binnendeur	Ja
Bruto inhoud, 3e oven	41 l	Aantal ruiten ovendeur	3
Materiaal ovenruimte	Ever Clean emaille	Aantal thermo-reflecterende ruiten	1
Aantal kookniveaus	2		

Type ovenrekken	Metalen zijsteunen	Veiligheidsthermostaat	Ja
Aantal lampen	1	Koelsysteem	Mantelkoeling
Soort verlichting	Halogeen	Afmetingen bruikbare interne ovenruimte (hxbxd)	169x440x443 mm
Vermogen lamp	40 W	Temperatuurregeling	Elektro-mechanisch
Deur openen	naar beneden	Grote vlakgrill - vermogen	2700 W
Uitneembare ovendeur	Ja	Type grill	Elektrisch
Volledig glazen binnendeur	Ja	Kantelbare grill	Ja

Opties derde oven

Minimum temperatuur	50 °C	Maximum temperatuur	260 °C
---------------------	-------	---------------------	--------

Meegeleverde accessoires primaire oven en kookplaat



Rek met achter- en zijstop	2	Inzetrooster	1
Bakplaat (40 mm)	1	Telescopische geleiders, gedeeltelijk uitschuifbaar	1

Meegeleverde accessoires secundaire oven



Ovenrooster met stop	3	Bordenwarmhouder	1
----------------------	---	------------------	---

Meegeleverde accessoires derde oven

Bakplaat (40 mm)	1
------------------	---

Elektrische aansluiting

Aansluitwaarde	15000 W	Lengte voedingskabel	150 cm
Stroom	42 A	Type stroomkabel	Double and Three Phase
Spanning	220-240 V	Frequentie	50 Hz
Spanning 2 (V)	380-415 V	Aansluitkast	5 polig
Electric cable	Installed, Single phase	Stekker	Nee



Compatibele Accessoires

AIRFRY

Airfryerrek AIRFRY . Ideaal voor traditioneel frituren in de oven, maar met minder calorieën en minder vet. Hiermee creëer je snel en eenvoudig gerechten zoals frites, gebakken groenten en vis, waardoor ze perfect bruin en krokant worden.



BBQ

Dubbelzijdig



BN640

Geëmailleerde bakplaat, 40 mm diep



GRILLPLATE

Universal griddle for induction, gas, ceramic and electric hobs. Non-stick surface ideal for cooking meat, cheese and vegetables. Dimensions: 410 x 240 mm.



GTT

Volledig uittrekbare telescopische geleiders (1 niveau)



KIT600TR93

Cover strip for hob back side, suitable for TR93 Victoria cookers



KITP65TR93

Depth extension kit (650 mm), nero, suitable for TR93 cookers



SCRP

Inductie- en keramische kookplaten en teppanyaki-schraper



AIRFRY2

Air fryer tray. Ideal for recreating traditional frying in the oven, but with fewer calories and less fat. It allows you to cook quickly and simply dishes such as French fries, fried vegetables and fish, ensuring perfect browning and crispiness.



BN620-1

Geëmailleerde bakplaat, 20 mm diep



BNP608T

Teflon-coated tray, 8 mm depth, to be placed on the grid



GTP

Gedeeltelijk uittrekbare telescopische geleiders (1 niveau)



KIT1TR9N

Splashback black, 90cm ,suitable for TR90 and TR93 Victoria cookers



KITH93

Height extension kit (950mm), black, suitable for TR93 cookers (945-960mm)



PALPZ

Pizzaschep met inklapbare handgreep breedte: 315 mm lengte: 325 mm



SFLK1

Kinderslot



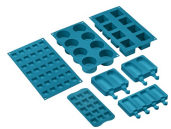

SMOLD

Set van 7 siliconen vormpjes voor ijsjes, ijslolly's, pralines, ijsblokjes of om etenswaren te portioneren. Bruikbaar van -60 ° C tot + 230 ° C



TPKPLATE

















Universal plate for induction, gas, ceramic and electric hobs. Non-stick surface ideal for cooking fish, eggs and vegetables. Dimensions: 410 X 240 mm.



















STONE

Rectangular refractory stone Ideal for cooking pizzas with the same results as a typical wood-fired oven. Can also be used for baking bread, focaccias and other recipes such as pies, flans or biscuits Dimensions:L42 x H1,8 x P37,5 cm.

Symbols glossary

 <p>Kinderslot: sommige modellen zijn voorzien van een apparaat om het programma / de cyclus te vergrendelen zodat het niet kan per ongeluk veranderd</p>	 <p>A: Droogprestaties van het product, gemeten vanaf A +++ tot D / G afhankelijk van de productfamilie</p>
 <p>Installation in column: Installation in column.</p>	 <p>Luchtkoelsysteem: om een veilig oppervlak te garanderen temperaturen.</p>
 <p>B: Energieklasse van het product, gemeten van A +++ tot D / G, afhankelijk van de productfamilie.</p>	 <p>Ontdooien op tijd: met deze functie wordt automatisch het tijdstip van ontdooien van voedsel bepaald</p>
 <p>Deuren met driedubbele beglazing: aantal glazen deuren.</p>	 <p>ECO-logic: optie stelt u in staat om de vermogenslimiet van de werkelijke energiebesparing van het apparaat te beperken</p>
 <p>Geëmailleerde binnenkant: De geëmailleerde binnenkant van alle Smeg-ovens heeft een speciale antacidumvoering die helpt om de binnenkant schoon te houden door de hoeveelheid kookvet te verminderen.</p>	 <p>Fan assisted base: the mix of fan and lower heating element alone allows to finish cooking foods already cooked on the surface but not internally more quickly. This system is recommended to finish cooking foods that are already well cooked on the surface, but not internally, which therefore require a moderate higher heat. Ideal for any type of food.</p>
 <p>Ventilator met bovenste en onderste elementen: de elementen in combinatie met de ventilator zijn bedoeld om een meer gelijkmatige warmte te bieden, een methode die vergelijkbaar is met conventioneel koken, dus voorverwarmen is vereist. Het meest geschikt voor items die langzaam koken vereisen.</p>	 <p>De ovenruimte wordt tegelijk door het onder- en bovenelement verwarmt. De hitteverdeling over het gerecht is afhankelijk van het niveau waarop men dit plaatst. Geschikt voor bakken op 1 niveau. Gerechten: alle ovenschotels, vlees, gevogelte, brood, (gevulde) taarten. Speciaal: gans en eend (bevatten veel vet).</p>
 <p>Circulaire: it is the perfect function for cooking all types of dishes in a more delicate way. The heat comes from the back of the oven and is distributed quickly and evenly. The fan is active. It is also ideal for cooking on multiple levels without mixing smells and flavors.</p>	 <p>ECO: low energy consumption cooking: this function is particularly suitable for cooking on a single shelf with low energy consumption. It is recommended for all types of food except those that can generate a lot of moisture (for example vegetables). To achieve maximum energy savings and reduce time, it is recommended to put the food in the oven without preheating the cooking compartment.</p>
 <p>De warmte wordt geproduceerd door het grill- en bovenelement. Verhitting over het volledige oppervlak. De thermostaat wordt, afhankelijk van het gerecht, in de regel op de maximale stand gezet. Bij een korte baktijd kan de ovendeur gesloten blijven; bij langere baktijd blijft deze gedeeltelijk geopend. Voor vleesgerechten (klein- en middelgroot), vleespennen, vis, groenten, gratineren etc.</p>	 <p>Light</p>

-  Overheat protection: The safety system that automatically turns off the hob in case of overheating of the control unit.
-  All glass inner door: All glass inner door, a single flat surface which is simple to keep clean.
-  verlichting
-  The oven cavity has 2 different cooking levels.
-  The oven cavity has 9 different cooking levels.
-  Electronic control: Allows you to maintain temperature inside the oven with the precision 2-3 ° C. This enables to cook meals that are very sensitive to temperature changes, such as cakes, souffles, puddings.
-  Vapor Clean: a simple cleaning function using steam to loosen deposits in the oven cavity.
-  The capacity indicates the amount of usable space in the oven cavity in litres.
-  Knobs control
-  Induction: The work of these hobs is based on the principle of electromagnetic induction. The heat is generated directly in the bottom of the pan during its contact with the hob.
-  The inner door glass: can be removed with a few quick movements for cleaning.
-  Plate rack warming: function for heating or keeping dishes warm. Place the baking tray on the lowest shelf and stack the dishes to be heated.
-  The oven cavity has 4 different cooking levels.
-  Telescopic rails: allow you to pull out the dish and check it without having to remove it from the oven entirely.
-  Tilting grill: the tilting grill can be easily unhooked to move the heating element and clean the roof of the appliance in one simple step.
-  The capacity indicates the amount of usable space in the oven cavity in litres.
-  The capacity indicates the amount of usable space in the oven cavity in litres.

Benefit (TT)

Induction hob

Inductie zorgt voor snel koken met nauwkeurige temperatuurregeling

Inductie is veilig, nauwkeurig en eenvoudig in gebruik en onderhoud – mits gebruikt met geschikt kookgerei

Vapor Clean

Door water in een uitsparing onderin de oven te plaatsen, ontstaat er stoom die aangekoekte resten losweekt en het schoonmaken vergemakkelijkt

Door water in een uitsparing onderin de ovenruimte te plaatsen, ontstaat er stoom die aangekoekte resten losweekt en het schoonmaken vergemakkelijkt

Buttons control

Simpele knopbediening voor het gemakkelijk instellen van de timer

True-convection

Optimale kookprestaties dankzij een ventilatiesysteem met circulerende hetelucht

Meerdere ventilatoren en verwarmingselementen zorgen voor een perfecte aerodynamische luchtstroom, waardoor gerechten sneller en gelijkmatig garen in de ovenruimte.

Multilevel cooking

Meerdere bakniveaus zorgen voor maximale flexibiliteit tijdens het koken

Multilevel halogen light

Interne halogeenverlichting op meerdere niveaus zorgt voor perfect zicht op elk gerecht

Removable inner glass

De binnenste ovenglaslagen zijn eenvoudig te verwijderen voor grondige reiniging

Tangential cooling

Nieuw koelsysteem met tangentiële ventilator en luchtstroom van deur tot achterwand voor betere temperatuurcontrole

Telescopic guides

Dankzij telescopische geleiders haal je bakplaten veilig en moeiteloos in en uit de oven

Adjustable height

Het kookoppervlak ligt gelijk met het werkblad dankzij verstelbare pootjes

Isothermic Cavity

De oven heeft een ventilator met een circulair verwarmingselement voor gelijkmatige heteluchtcirculatie

BBQ (optional accessory)

Barbecue-effect in de oven met het dubbelzijdige grillrooster (optioneel BBQ-accessoire)

Pizza stone (optional accessory)

Bakken op vuurvaste steen voor luchtige en krokante pizza's en deegwaren (optioneel STONE-accessoire)

Cold door

Het buitenste glas van de ovendeur blijft koud tijdens gebruik, wat brandwonden voorkomt

AirFry (AIRFRY optional accessory)

Lichter en krokanter resultaat met het airfry-mandje (optioneel accessoire)

Single turbine

De oven heeft een ventilator met een circulair verwarmingselement voor gelijkmatige heteluchtcirculatie