

TR93P

Cooker size	90x60 cm
N. of cavities with energy label	2
Cavity heat source	ELECTRICITY
Hob type	Gas
Type of main oven	Thermo-ventilated
Type of second oven	Thermo-ventilated
Cleaning system main oven	Vapor Clean
EAN code	8017709181703
Energy efficiency class	A
Energy efficiency class, second cavity	B



Aesthetics



Aesthetic Design	Victoria	Type of control knobs	Smeg Victoria
Colour	Victoria	Controls colour	Stainless steel
Command panel finish	Cream	No. of controls	10
Logo	Enamelled metal	Serigraphy colour	Black
Logo position	assembled 50's	Display	Electronic 5 buttons
Upstand	Upstand+ Command panel	Door	With frame
Hob colour	Yes	Glass type	Black
Type of pan stands	Black enamel	Handle	Smeg Victoria
Type of control setting hob	Cast Iron	Handle Colour	Brushed stainless steel
	Control knobs	Plinth	Anthracite

Programme / Functions

No. of cooking functions 5
 Traditional cooking functions



Static



Fan assisted



Circulaire



Eco



Fan assisted base

Cleaning functions



Vapor clean

Other functions

 Defrost by time

Programs / Functions Auxiliary Oven

Cooking functions cavity 2 1
Traditional cooking functions, cavity 2

 Circulaire

Programs / Functions Third Oven

No. of functions third oven 1

Oven light 

Full grill 

Hob technical features

UR

Total no. of cook zones 6

Front left - Gas - 2UR (dual) - 4.20 kW

Rear left - Gas - AUX - 1.00 kW

Front centre - Gas - AUX - 1.00 kW

Rear centre - Gas - Semi Rapid - 1.80 kW

Front right - Gas - Semi Rapid - 1.80 kW

Rear right - Gas - Rapid - 2.90 kW

Type of gas burners Standard

Gas safety valves Yes

Automatic electronic ignition Yes

Burner caps Matt black enamelled

Main Oven Technical Features



No. of lights 1

Fan number 1

Net volume of the cavity 61 l

Gross volume, 1st cavity 70 l

Cavity material Ever Clean enamel

No. of shelves 4

Type of shelves Metal racks

Light type Halogen

Light Power 40 W

Cooking time setting Start and Stop

Door opening Side opening

Total no. of door glasses 3

No. of thermo-reflective door glasses 1

Safety Thermostat Yes

Cooling system Tangential

Usable cavity space dimensions (HxWxD) 316x460x412 mm

Temperature control Electro-mechanical

Lower heating element power 1200 W

Upper heating element - Power 1000 W

Removable door	Yes	Grill element	1700 W
Full glass inner door	Yes	Large grill - Power	2700 W
Removable inner door	Yes	Circular heating element - Power	2000 W
		Grill type	Electric
		Tilting grill	Yes

Options Main Oven

Timer	Yes	Minimum Temperature	50 °C
End of cooking acoustic alarm	Yes	Maximum temperature	260 °C

Second Oven Technical Features



Net volume of the second cavity	62 l	Full glass inner door	Yes
Gross volume, 2nd cavity	69 l	Removable inner door	Yes
Cavity material	Ever Clean enamel	No. total door glasses	2
No. of shelves	9	No. thermo-reflective door glasses	1
Type of shelves	Metal racks	Safety Thermostat	Yes
No. of lights	1	Cooling system	Tangential
Light type	Halogen	Usable cavity space dimensions (HxWxD)	605x275x370 mm
Light Power	40 W	Temperature control	Electro-mechanical
Door opening	Side opening	Circular heating element - Power	2500 W
Removable door	Yes	Grill type	Electric

Options Auxiliary Oven

Minimum Temperature	50 °C	Maximum temperature	245 °C
---------------------	-------	---------------------	--------

Third Oven Technical Features



Net volume, 3rd cavity	35 l	Removable inner door	Yes
Gross volume, 3rd cavity	41 l	No. total door glasses	3
Cavity material	Ever Clean enamel	No. of thermo-reflective door glasses	1
No. of shelves	2	Safety Thermostat	Yes
Type of shelves	Metal racks	Cooling system	Tangential
No. of lights	1	Usable cavity space dimensions (HxWxD)	169x440x443 mm
Light type	Halogen	Temperature control	Electro-mechanical
Light Power	40 W	Large grill - Power	2700 W
Door opening	Flap down	Grill type	Electric
Removable door	Yes		

Full glass inner door	Yes	Tilting grill	Yes
-----------------------	-----	---------------	-----

Options Third Oven

Minimum Temperature	50 °C	Maximum temperature	260 °C
---------------------	-------	---------------------	--------

Accessories included for Main Oven & Hob



Cast iron wok support	1	40mm deep tray	1
Moka stand in cast iron	1	Grill mesh	1
Rack with back and side stop	2	Telescopic Guide rails, partial Extraction	1

Accessories included for Secondary Oven



Oven grid with back stop	3	Plate rack/warmer	1
--------------------------	---	-------------------	---

Accessories included for Third Oven

Rack with back and side stop	1	40mm deep tray	1
------------------------------	---	----------------	---

Electrical Connection

Plug	Not present	Installed electric cable	Yes, Single phase
Electrical connection rating	8300 W	Additional connection modalities	Yes, Double and Three Phase
Current	36 A	Frequency	50/60 Hz
Voltage	220-240 V	Terminal block	5 poles
Voltage 2 (V)	380-415 V		

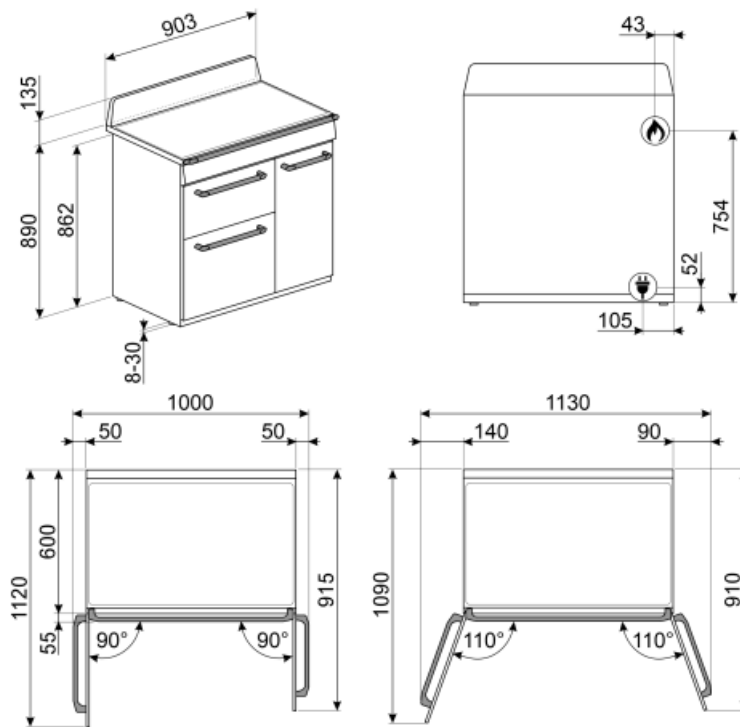

Not included accessories



TPKTR9

Stainless steel teppanyaki plate, suitable for Victoria TR9, Master and Sinfonia cookers



SFLK1

Child lock



PRTX

Refractory pizza stone with handles. D=35cm Not suitable for microwave ovens. Suitable for gas ovens, to be put on the griddle.



BGTR9

Cast iron grill plate suitable for 90 cm Victoria, 60 and 90 cm Master and Sinfonia cookers



BN620-1

Enamelled tray suitable for 45cm and 60cm ovens. Depth 20 mm. Perfect for a wide range of savoury and sweet baking.



BBQ

Double sided plate BBQ. Suitable for recreating succulent and crispy dishes in the oven with the typical taste of grilled cooking. The ribbed side is particularly suitable for meats and cheeses. The smooth side for fish, seafood and vegetables.



PALPZ

Pizza shovel with folding handle. Dimensions L31.5 x H32.5 cm. Easy and convenient to use and store. Perfect for serving pizza, bread and savory pastries in a safe and professional way.



BN640

Enamelled tray suitable for 45cm and 60cm ovens. Depth 540 mm. Perfect for cooking and roasting meat and fish in sauces. Also ideal for experimenting with lighter and crunchy side dishes



AIRFRY

Air fryer rack AIRFRY . Ideal for recreating traditional frying in the oven, but with fewer calories and less fat. It allows you to cook quickly and simply dishes such as French fries, fried vegetables and fish, ensuring perfect browning and crispiness.



GTP

Partially extractable telescopic guides (1 level), suitable for traditional ovens. Made in stainless steel, they guarantee stability and facilitate the smooth extraction of the trays.



BNP608T

Teflon-coated tray, 8mm depth, to be placed on the grid



KIT1TR9N

Splashback black, 90cm ,suitable for TR90 and TR93 Victoria cookers



KITH93

Height extension kit (950mm), black, suitable for TR93 cookers (945-960mm)



STONE

Rectangular refractory stone Ideal for cooking pizzas with the same results as a typical wood-fired oven. Can also be used for baking bread, focaccias and other recipes such as pies, flans or biscuits Dimensions:L42 x H1,8 x P37,5 cm.



GTT



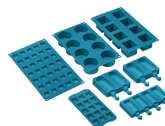















Totally extractable telescopic guides (1 level), suitable for traditional ovens. Made in stainless steel, they guarantee stability and facilitate the smooth extraction of the trays.

















SMOLD

Set of 7 silicone moulds for ice creams, ice lollies, pralines, ice cubes or to portion food. Usable from -60°C to +230°C

Symbols glossary (TT)

			B: Product energy rating, measured from A+++ to D / G depending on the product family.
	Heavy duty cast iron pan stands: for maximum stability and strength.		Installation in column: Installation in column
	Air cooling system: to ensure a safe surface temperatures.		Defrost by time: Manual defrost function. At the end of the set duration, the function stops.
	Double glazed doors: Number of glazed doors.		Triple glazed doors: Number of glazed doors.
	Ever Clean Enamel: Ever Clean enamel is applied electrostatically, corner to corner and edge to edge to prevent cracking or cracks over time. It is a particular pyrolytic enamel, resistant to acids which, in addition to being pleasantly bright, promotes greater cleaning of the oven walls, thanks to its lower porosity. It is baked at over 850 ° C and slowly polymerized at a scientifically determined rate to ensure uniform depth and strength Ever Clean enamel creates an impeccable finish both on the inside of the oven and on the trays, making the surfaces of the oven incredibly easy to maintain over time as it reduces the adhesion of fat during cooking		Fan assisted base: the mix of fan and lower heating element alone allows to finish cooking foods already cooked on the surface but not internally more quickly. This system is recommended to finish cooking foods that are already well cooked on the surface, but not internally, which therefore require a moderate higher heat. Ideal for any type of food.
	Fan assisted: Intense and homogeneous traditional cooking, also suitable for complex recipes. The fan is active and the heat comes from below and from above at the same time. Ventilated cooking ensures a faster and more homogeneous result, leaving fragrant foods outside and moister inside. Ideal for baked pasta, biscuits, roasts and cobblers.		Static: Traditional cooking suitable for the preparation of one dish at a time. The fan is not active and the heat comes from below and from above at the same time. Static cooking is slower and more delicate, ideal in order to get well cooked and dry dishes even inside. Ideal for cooking all types of roasts, fatty meats, bread, filled cakes.
	Circulaire: it is the perfect function for cooking all types of dishes in a more delicate way. The heat comes from the back of the oven and is distributed quickly and evenly The fan is active. It is also ideal for cooking on multiple levels without mixing smells and flavors.		ECO: low energy consumption cooking: this function is particularly suitable for cooking on a single shelf with low energy consumption. It is recommended for all types of food except those that can generate a lot of moisture (for example vegetables). To achieve maximum energy savings and reduce time, it is recommended to put the food in the oven without preheating the cooking compartment
	Grill element: Using of grill gives excellent results when cooking meat of medium and small portions, especially when combined with a rotisserie (where possible). Also ideal for cooking sausages and bacon.		Light
	Gas ovens offer instantaneous heat control, reduced cooking times and the ability to bake at much lower temperatures than electric ovens.		All glass inner door: All glass inner door, a single flat surface which is simple to keep clean.

-
-  The inner door glass: can be removed with a few quick movements for cleaning.
 -  Plate rack warming: function for heating or keeping dishes warm. Place the baking tray on the lowest shelf and stack the dishes to be heated.
 -  The oven cavity has 4 different cooking levels.
 -  Telescopic rails: allow you to pull out the dish and check it without having to remove it from the oven entirely.
 -  Tilting grill: the tilting grill can be easily unhooked to move the heating element and clean the roof of the appliance in one simple step.
 -  Vapor Clean: a simple cleaning function using steam to loosen deposits in the oven cavity.
 -  The capacity indicates the amount of usable space in the oven cavity in litres.
 -  Knobs control
 -  Side lights: Two opposing side lights increase visibility inside the oven.
 -  The oven cavity has 2 different cooking levels.
 -  The oven cavity has 9 different cooking levels.
 -  Electronic control: Allows you to maintain temperature inside the oven with the precision 2-3 ° C. This enables to cook meals that are very sensitive to temperature changes, such as cakes, souffles, puddings.
 -  Ultra rapid burners: Powerful ultra rapid burners offer up to 5kw of power.
 -  The capacity indicates the amount of usable space in the oven cavity in litres.
 -  The capacity indicates the amount of usable space in the oven cavity in litres.

Benefit (TT)

True-convection

The best cooking performances guaranteed by ventilated circular flow

Multiple fans and heating elements guarantee the perfect aerodynamic heat flow, allowing homogeneous and quicker cooking inside the cavity.

Gas hob

Gas provides permanent control of the heat source and the temperature change is immediate

Equipped with a thermocouple, the gas supply is cut off if the flame is extinguished for greater safety.

Vapor Clean

By inserting water into a recess at the bottom of the cavity, steam is generated, which softens the residue and facilitates its removal

By inserting water into a recess at the bottom of the cavity, steam is generated, which softens the residue and facilitates its removal.

Single turbine

The oven has a fan equipped with a circular heating element allowing cooking with rotating heat

Isothermic Cavity

The best cooking performance at the highest energy efficiency

Tangential cooling

New cooling system with tangential fan and airflow from the door to the splashback

Multilevel halogen light

Internal halogen lighting on different levels guarantees excellent visibility

Buttons control

Easy and intuitive timer setting with a simple buttons

Telescopic guides

Easy extraction and safe insertion of trays into the oven thanks to telescopic guides

Adjustable height

Cooker top flushed with the working area thanks to adjustable feet

Removable inner glass

Internal door glasses are easily removable for complete cleaning

Multilevel cooking

Several cooking levels allow maximum flexibility of use

Cold door

During any function, the external door glass is cold, avoiding any risk of burns

AirFry (AIRFRY optional accessory)

Lighter and tastier food thanks to airfry basket (optional accessory)

BBQ (optional accessory)

Barbeque cooking directly in the oven with the double-sided grill (BBQ optional accessory)

Pizza stone (optional accessory)

Baking with refractory stone for soft and crispy pizza and yeast products (STONE optional accessory)