

UKC81721E



Product Family	Refrigerator
Installation	Built-in
Category	Bottom Mount
Built-in niche	178
Reference width	Until 60 cm
Reference height	160 - 200 cm
Cooling type	Fan assisted
Defrost	Automatic for refrigerator, manual for freezer
Hinge type	Sliding
Kitchen panel	Not supplied
Hinge position	Right
Reversible door	Yes
EAN code	8017709323950



Aesthetics



Aesthetics	Universal	Door shelves profile colour	Silver
Colour	Silver	Drawers profile colour	Silver
Material	Metal sheet	Colour of glass shelf profile	Chrome
Side material	Steel	Display	LED
Side colour	Silver	Display position	Interior
Logo	Silk screen		

Refrigerator compartment features



Number of compartments	2	Crisper Cover	Yes
Compartment types	Fruit and vegetable compartment	Type of crisper/vegetable drawers cover	Glass
No. of adjustable shelves	4	No. of lights	1
Number of fruit and vegetables drawers	2	Internal light in fridge	Yes
Shelves material	Glass	Type of internal light (fridge)	LED
Type of crisper/vegetable drawers cover	Standard		

Refrigerator Inner Door

No. of door shelves with transparent cover 1

No. of bottle shelves 1

Number of adjustable door shelves 2

Other Refrigerator features



Accessories

Egg tray

Fan

Yes

Freezer compartment features

Number of drawers 3

Other Freezer features

Accessories

1 ice box

Other technical features



Functions display

Fast freezing

Fast freezing button

Yes

Temperature alarm lamp

Yes

Door open alarm

Yes

Type of temperature control

Electronic

No. of compressors

1

Refrigerant gas type

R600a

Type of compressor

Standard

Refrigerant Quantity (g)

82 g

Foam agent

Cyclopentane

Performance / Energy Label



Annual energy consumption 220 kWh/year

Total volume 272 l

Energy efficiency class E

Thaw time 11.50 h

Airborne acoustical noise emission class B

4 star - Freezing capacity 3.3 kg/24h

Total volume 269 l

Climatic class SN, N, ST, T

Sum of the volumes of the frozen compartment(s) 73 l

EEI 100 %

Sum of the volumes of the chill compartment(s) and the unfrozen compartment(s) 196 l

Electrical Connection





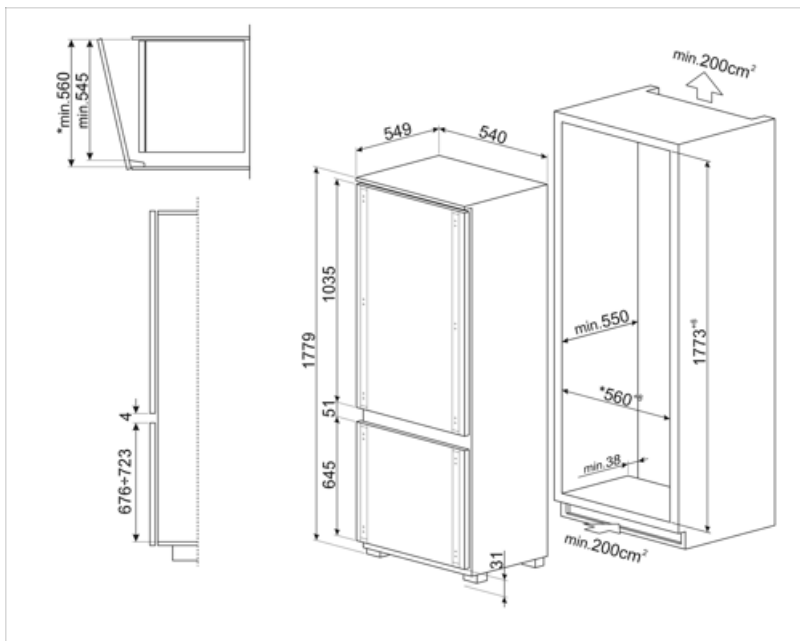

Nominal power	100 W	Frequency (Hz)	50 Hz
Current	1.2 A	Power supply cable length	240 cm
Voltage (V)	230-240 V	Plug	(G) UK e Singapore

Logistic Information

Width (mm)	540 mm	Product Height with feet	1772 mm
Width of the built-in niche	560 mm	Height of the built-in niche	1780 mm
Depth of the built-in niche	550 mm		



Symbols glossary

	The automatic defrost system works by automatically defrosting at regular intervals eliminating the need to defrost altogether.		Energy efficiency class E
	LED display: to show programmes, functions and options selected and the time to the end of the cycle.		Ventilated: Forced distribution of cold air in the refrigerator compartment, which allows even temperature distribution within the fridge.
	Fast freezing: The fast freezing function brings the temperature of the compartment down when activated a few hours prior to usage.		LED interior lighting: is a more energy efficient and long lasting way of illuminating the interior of the appliance.
	Built-in niche		