

UKC81721E



Product Family	Refrigerator
Installation	Built-in
Category	Bottom Mount
Built-in niche	178
Reference width	Until 60 cm
Reference height	160 - 200 cm
Cooling type	Fan assisted
Defrost	Automatic for refrigerator, manual for freezer
Hinge type	Sliding
Kitchen panel	Not supplied
Hinge position	Right
Reversible door	Yes
EAN code	8017709323950



Aesthetics



Aesthetic	Universale	Door shelves profile color	Silver
Colour	Silver	Drawers profile color	Silver
Material	Metal sheet	Color of glass shelf profile	Chrome
Side material	Steel	Display	LED
Side colour	Silver	Display position	Interno (cella frigo)
Logo	Silk screen		

Refrigerator compartment features



Number of compartments	2	Crisper Cover	Yes
Compartment types	Fruit and vegetable compartment	Type of crisper/vegetable drawers cover	Glass
No. of adjustable shelves	4	No. of lights refrigerator compartment	1
Number of fruit and vegetables drawers	2	Internal light in fridge	Yes
Shelves material	Glass	Type of internal light (fridge)	LED
Type of crisper/vegetable drawers cover	Standard		

Refrigerator Inner Door

No. of door shelves with transparent cover	1	No. of bottle shelves	1
Number of adjustable door shelves	2		

Other Refrigerator features



Accessories	Egg tray	Fan	Yes
-------------	----------	-----	-----

Freezer compartment features

Number of drawers	3
-------------------	---

Other Freezer features

Accessories	1 ice box
-------------	-----------

Other technical features



Functions display	Fast freezing
Fast freezing button	Yes
Temperature alarm lamp	Yes
Door open alarm	Yes
Type of temperature control	Electronic
No. of compressors	1
Refrigerant gas type	R600a
Type of compressor	Standard
Refrigerant Quantity (g)	82 g
Foam agent	Cyclopentane

Performance / Energy Label - Reg. 2019



Annual energy consumption	220 kWh/a	Total gross volume	272 l
Energy efficiency class	E	Temperature Rise Time	11.50 h
Airborne acoustical noise emission class	B	4 star - Freezing capacity	3.3 kg/24h
Total net volume	269 l	Climate class	SN, N, ST, T
Sum of the volumes of the frozen compartment(s)	73 l	EEl	100 %

Sum of the volumes of the chill compartment(s) and the unfrozen compartment(s) 196 l

Electrical Connection





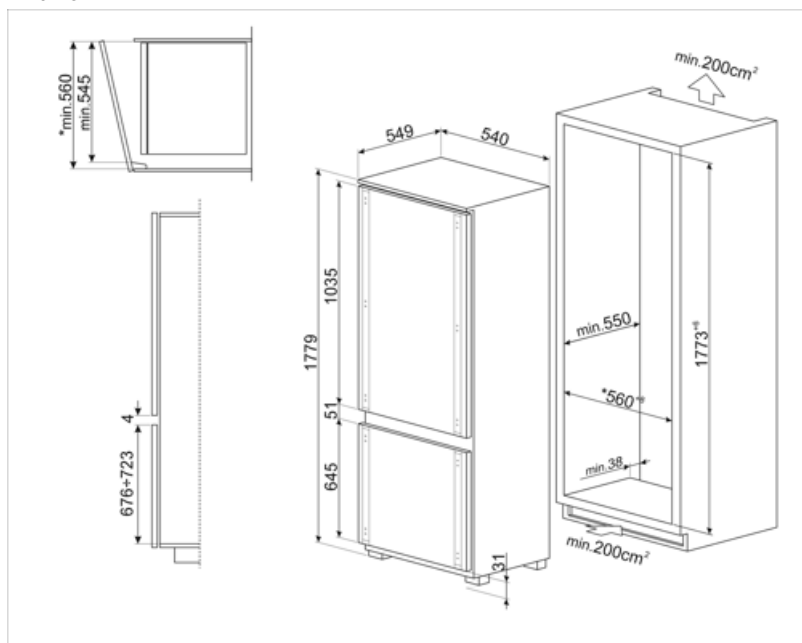

Electrical connection rating	100 W	Frequency (Hz)	50 Hz
Current	1.2 A	Power supply cable length	240 cm
Voltage (V)	230-240 V	Plug	(G) UK e Singapore

Logistic Information

Width	540 mm	Height	1772 mm
Width of the built-in niche	560 mm	Height of the built-in niche	1780 mm
Depth of the built-in niche	550 mm		



Symbols glossary

- | | | | |
|--|---|---|--|
|  | The automatic defrost system works by automatically defrosting at regular intervals eliminating the need to defrost altogether. |  | Energy efficiency class E |
|  | LED display: to show programmes, functions and options selected and the time to the end of the cycle. |  | Ventilated: Forced distribution of cold air in the refrigerator compartment, which allows even temperature distribution within the fridge. |
|  | Fast freezing: The fast freezing function brings the temperature of the compartment down when activated a few hours prior to usage. |  | LED interior lighting: is a more energy efficient and long lasting way of illuminating the interior of the appliance. |
|  | Built-in niche | | |