

UKC8173N1E



Product Family	Refrigerator
Installation	Built-in
Category	Bottom Mount
Built-in niche	178
Reference width	Until 60 cm
Reference height	160 - 200 cm
Cooling type	Fan assisted refrigerator, no-frost freezer
Defrost	Automatic
Hinge type	Sliding
Kitchen panel	Not supplied
Hinge position	Right
Reversible door	Yes
EAN code	8017709331726



Aesthetics



Aesthetic	Universale	Logo	Silk screen
Colour	White	Door shelves profile color	Silver
Material	Metal sheet	Drawers profile color	Silver
Handle type	Fixed	Color of glass shelf profile	Chrome
Side material	Steel	Display	LED
Side colour	White	Display position	Interno (cella frigo)

Refrigerator compartment features



No. of adjustable shelves	4	Type of crisper/vegetable drawers cover	Glass
Number of fruit and vegetables drawers	2	No. of lights refrigerator compartment	1
Shelves material	Glass	Internal light in fridge	Yes
Type of crisper/vegetable drawers cover	Standard	Type of internal light (fridge)	LED
Crisper Cover	Yes		

Refrigerator Inner Door

No. of door shelves with transparent cover	1	No. of bottle shelves	1
--	---	-----------------------	---

Number of adjustable door shelves 2

Other Refrigerator features

Accessories Egg tray

Freezer compartment features

Number of drawers 3

Other Freezer features

Accessories 1 ice box

Other technical features



Functions display	Fast freezing
Fast freezing button	Yes
Type of temperature control	Electronic
No. of compressors	1
Refrigerant gas type	R600a
Type of compressor	Standard
Refrigerant Quantity (g)	50 g
Foam agent	Cyclopentane

Performance / Energy Label - Reg. 2019



Annual energy consumption	216 kWh/a	Airborne acoustical noise emissions	35 dB(A) re 1 pW
Energy efficiency class	E	Temperature Rise Time	9,50 h
Airborne acoustical noise emission class	B	4 star - Freezing capacity	4,5 kg/24h
Total net volume	257 l	Climate class	SN, N, ST, T
Sum of the volumes of the frozen compartment(s)	62 l	EEl	100 %
Sum of the volumes of the chill compartment(s) and the unfrozen compartment(s)	195 l		

Electrical Connection

Frequency (Hz) 50 Hz





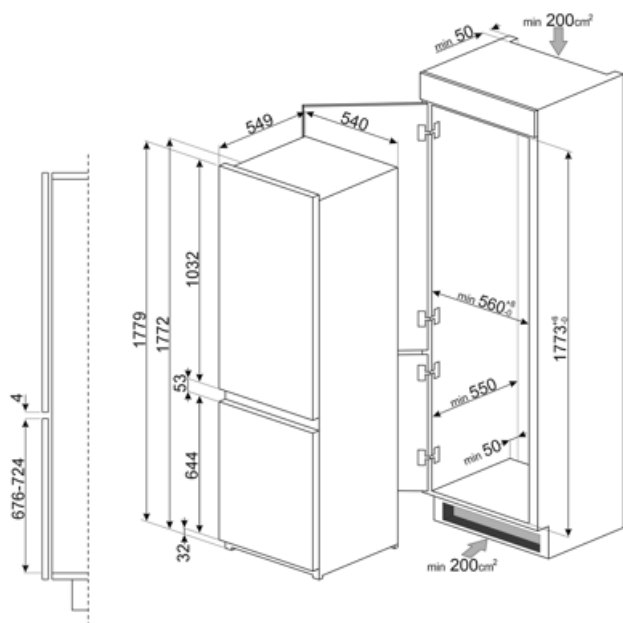

Electrical connection rating	100 W	Power supply cable length	240 cm
Current	1,1 A	Plug	(G) UK e Singapore
Voltage (V)	230-240 V		

Logistic Information

Width	546 mm	Depth of the built-in niche	550 mm
Width of the built-in niche	560 mm	Height	1772 mm
Depth without handle	549 mm	Height of the built-in niche	1780 mm



Symbols glossary

	The automatic defrost system works by automatically defrosting at regular intervals eliminating the need to defrost altogether.		Energy efficiency class E
	LED display: to show programmes, functions and options selected and the time to the end of the cycle.		Fast freezing: The fast freezing function brings the temperature of the compartment down when activated a few hours prior to usage.
	LED interior lighting: is a more energy efficient and long lasting way of illuminating the interior of the appliance.		Built-in niche
	No Frost: The No Frost and Frost free systems prevent ice from forming so that no defrosting is required.		