

# UKC8173N1F



<b>Product Family</b>	Refrigerator
<b>Installation</b>	Built-in
<b>Category</b>	Bottom Mount
<b>Built-in niche</b>	178
<b>Reference width</b>	Until 60 cm
<b>Reference height</b>	160 - 200 cm
<b>Cooling type</b>	Fan assisted refrigerator, no-frost freezer
<b>Defrost</b>	Automatic
<b>Hinge type</b>	Sliding
<b>Hinge position</b>	Right
<b>Reversible door</b>	Yes
<b>EAN code</b>	8017709295318



## Aesthetics



<b>Aesthetics</b>	Universal	<b>Logo</b>	Silk screen
<b>Colour</b>	White	<b>Door shelves profile colour</b>	Silver
<b>Material</b>	Metal sheet	<b>Drawers profile colour</b>	Silver
<b>Handle type</b>	Fixed	<b>Colour of glass shelf profile</b>	Chrome
<b>Side material</b>	Steel	<b>Display</b>	LED
<b>Side colour</b>	White	<b>Display position</b>	Interior

## Refrigerator compartment features



<b>No. of adjustable shelves</b>	4	<b>Crisper Cover</b>	Yes
<b>Number of fruit and vegetables drawers</b>	2	<b>Type of crisper/vegetable drawers cover</b>	Glass
<b>Shelves material</b>	Glass	<b>Internal light in fridge</b>	Yes
<b>Type of crisper/vegetable drawers cover</b>	Standard	<b>Type of internal light (fridge)</b>	LED

## Refrigerator Inner Door

<b>No. of door shelves with transparent cover</b>	1	<b>No. of bottle shelves</b>	1
---	---	------------------------------	---

Number of adjustable door shelves 2

## Other Refrigerator features



Accessories Egg tray Fan Yes

## Freezer compartment features

Number of drawers 3

## Other Freezer features

Accessories 1 ice box, 1 eutectic

## Other technical features



Functions display	Fast freezing
Fast freezing button	Yes
Type of temperature control	Electronic
No. of compressors	1
Refrigerant gas type	R600a
Type of compressor	Standard
Refrigerant Quantity (g)	50 g
Foam agent	Cyclopentane

## Performance / Energy Label



Annual energy consumption	268 kWh/year	Noise level	36 dB(A) re 1 pW
Energy efficiency class	F	Thaw time	9,00 h
Airborne acoustical noise emission class	C	4 star - Freezing capacity	5,0 kg/24h
Total volume	254 l	Climatic class	SN, N, ST, T
Sum of the volumes of the frozen compartment(s)	61 l	EEl	125 %
Sum of the volumes of the chill compartment(s) and the unfrozen compartment(s)	193 l		

## Electrical Connection







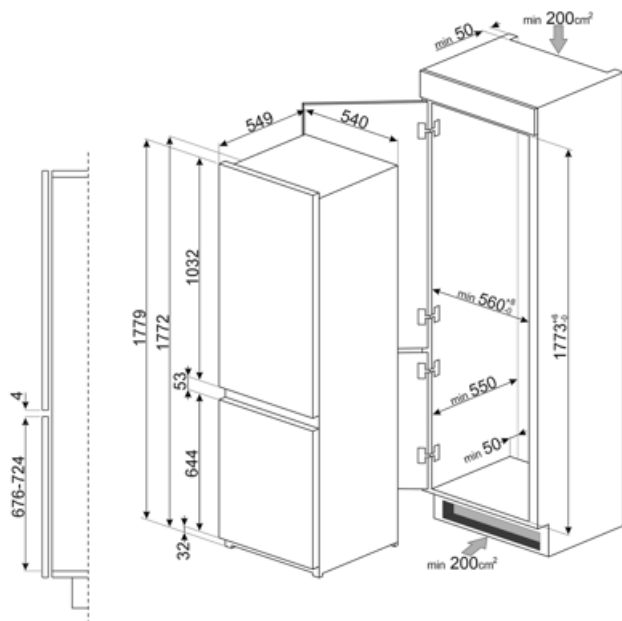



Nominal power	100 W	Frequency (Hz)	50 Hz
Current	1,1 A	Power supply cable length	240 cm
Voltage (V)	230-240 V	Plug	(G) UK e Singapore

## Logistic Information

Width (mm)	548 mm	Product Height with feet	1772 mm
Width of the built-in niche	560 mm	Height of the built-in niche	1780 mm
Depth without handle	549 mm	Product width with maximum doors opening	549 mm
Depth of the built-in niche	550 mm	Spacer depth	38 mm



## Symbols glossary

	4 stars freezing compartment for better food preservation.		A+: Energy efficiency class A+ helps to save up to 10% energy compared to class A. Maximum performance with minimum consumption is guaranteed.
	The automatic defrost system works by automatically defrosting at regular intervals eliminating the need to defrost altogether.		LED display: to show programmes, functions and options selected and the time to the end of the cycle.
	Ventilated: Forced distribution of cold air in the refrigerator compartment, which allows even temperature distribution within the fridge.		Fast freezing: The fast freezing function brings the temperature of the compartment down when activated a few hours prior to usage.
	LED interior lighting: is a more energy efficient and long lasting way of illuminating the interior of the appliance.		Built-in niche
	No Frost: The No Frost and Frost free systems prevent ice from forming so that no defrosting is required.		Energy efficiency class F