

# UM103PRA2

Sink material Stainless steel  
 Type Monoblock bowl  
 No. of bowls 1  
 EAN code 8017709261146



## Aesthetics



<b>Aesthetic</b>	Universal	<b>Logo</b>	Not present
<b>Serie</b>	Alba	<b>Alternative colours available</b>	No
<b>Colour</b>	Copper	<b>Half bowl cup drainer</b>	No
<b>Acabamento</b>	PVD Escovado	<b>Tap hole / precut tap hole</b>	No Taphole
<b>Building in type</b>	Undermount		

	Bowl type	Bowl dimensions, WxDxH (mm)	Bowl depth (mm)	Overflow	Strainer position	Strainer dimension
Bowl	Round	diametro 375	200	Yes, traditional	Wall position	3.5"

## Technical Features



<b>Características</b>	Espeçura de revestimento, Ecológico, Fácil de limpar, hipoalergênico	<b>Diâmetro do furo da torneira</b>	35 mm
<b>Revestimento PVD</b>		<b>Popup command</b>	No
<b>Dimensions of the product (mm)</b>	200x435x435 mm	<b>Pre-assembled gasket</b>	No
<b>Dimensão do recorte sob a montagem (mm)</b>	374 mm	<b>No. of clips</b>	3
<b>Base unit size</b>	45 cm	<b>Type of clips</b>	Undermount clip
<b>Tap hole</b>	No		

## Accessories Included

Accessories for installation	Strainer, Fixing clips	Basket	No
Colander	No	Wooden board	No
Rondò Cover waste kit	No	White board	No
Glass board	No		

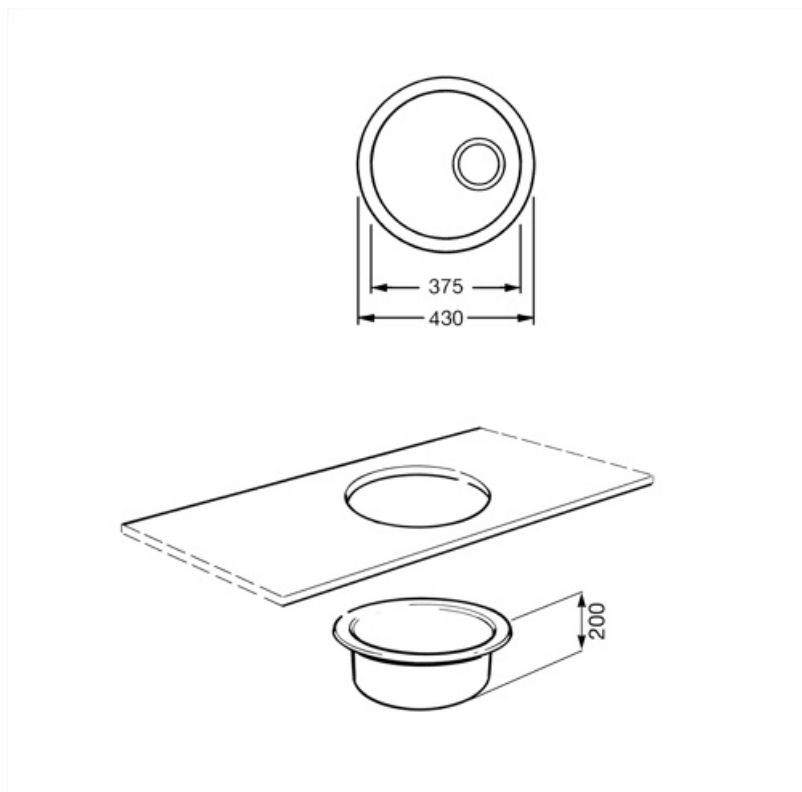

## Compatible Accessories



**3712**

Pias de bacia única sifão (conexão da máquina lava-louça incluída)



**KITDS**

Botão redondo dispensador de sabão



**KITFD050**

Eliminação de resíduos 0,5 CV Motor: 1/2 cv Serve para todas as pias com saída de resíduos de 3 1/2"



**KITFD100**

Eliminação de resíduos 1 CV Motor: 1 cv Serve para todas as pias com saída de resíduos de 3 1/2"



**3713**

Sifão bacias duplas pias (conexão da máquina lava-louça incluída)



**KITDSQ**

Botão quadrado do dispensador de sabão



**KITFD075**

Eliminação de resíduos 0,75 CV Motor: 3/4 CV Adapta-se a todas as pias com saída de resíduos de 3 1/2"









**STABMIX**

estabilizador para misturadores

---

## Symbols glossary

---

- |  |   |   |  |
|--|---|---|--|
|  | Largura do armário necessária para a instalação da pia  |  | Profundidade da pia - dependendo do modelo, a profundidade pode ser de 13 a 24,5 |
|  | Instalação sob o tampo da mesa: A pia é fixada sob o tampo da mesa, que estende a superfície de trabalho e a profundidade da pia. |  | Espessura do revestimento entre 0,2mm e 2mm                                      |
|  | Fácil de limpar   |  | O processo de fabricação do tratamento PVD é 100% verde e ecologicamente correto |
|  | Os revestimentos PVD são hipoalergênicos e adequados para uso em contato com alimentos  |   |  |

---

## Benefit (TT)

---

### **One bowl**

A single bowl for greater adaptability, capacity and space optimisation