

VFU50SFR

Sink material	Stainless steel
Sink type	Single-pressed bowl
No. of bowls	1
EAN code	8017709304669



Aesthetics



Aesthetics	Universal	Building in type	Flush fitted, Flat, Undermount
Colour	Stainless steel	Logo	Embossed
Finishing	Brushed	Tap hole / precut tap hole	No Taphole
Series	Mira		

	Bowl type	Bowl dimensions, WxDxH (mm)	Bowl depth (mm)	Radius corner bowl	Overflow	Strainer position	Strainer dimension
Bowl	Minimum radius	500 x 400 x 200	200	15	Yes, flush fitted	Wall position	3.5"

Technical Features



Dimensions of the product WxDxH (mm)	200x540x440 mm	Height from kitchen top	1 mm
Cutout dimension (mm)	525*425 mm	Base unit size	60 cm
Cutout dimension undermount (mm)	504*404 mm	No. of clips	8
Cutout radius	17 mm	Type of clips	Standard + undermount clip

Accessories Included

Accessories for
installation

Strainer, Siphon with
dishwasher outlet
connection, Fixing clips,
Silicone

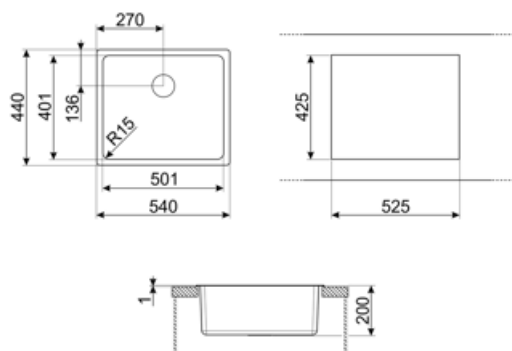

Compatible Accessories



3712

Siphon single bowl sinks (dishwasher connection included)



CB25MN

Single HPE chopping board to fit minimum radius bowls, black matt, measures 250 x 410 H 12 mm, dishwasher safe



COL19H

St/Steel colander to fit MINIMUM radius mm bowl, measures 200 x 410 x 100 mm



DB34

Cestello in filo inox per abbinamento alle vasche di dimensione 340*400 mm



KITDSQ

Soap dispenser Square knob



KITFD075

Waste disposal 0,75 HP Motor: 3/4 horsepower Fits all sinks with 3 1/2" waste outlet



RND1V

Rondò waste kit 1 bowl with standard overflow



3713

Siphon double bowls sinks (dishwasher connection included)

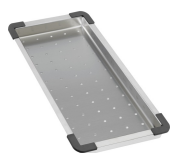

COL19

St/Steel colander to fit MINIMUM radius mm bowl, measures 200 x 410 x 26 mm



COL36

St/steel colander for MINIMUM radius bowls, measures 370 x 410 x 30 mm



KITDS

Soap dispenser Round knob



KITFD050





Waste disposal 0,5 HP Motor: 1/2 horsepower Fits all sinks with 3 1/2" waste outlet



KITFD100

Waste disposal 1 HP Motor: 1 horsepower Fits all sinks with 3 1/2" waste outlet

Symbols glossary

- | | | | |
|--|---|---|---|
|  | Cupboard width required for sink installation |  | Sink depth - depending on the model, the depth can be from 13 to 24,5 |
|  | Flat: Installation of product with flat edge. |  | Flush-fitted installation: Models of sinks/hobs which are integrated flush with the tabletop of a kitchen unit. |
|  | Under table top installation: The sink is fixed under tabletop, which extends the work surface and the depth of the sink. | | |

Benefit

One bowl

A single bowl for greater adaptability, capacity and space optimisation