

VFU50SFR

Materiaal	Inox
Type spoelbak	Enkel geperste spoelbak
Aantal spoelbakken	1
EAN-code	8017709304669



Design



Design	Universeel	Type inbouw	Vlak opbouw, Plat , Onderbouw
Kleur	Inox	Logo	In reliëf
Afwerking	Geborsteld inox	Geperforeerde opening voor kraan	Geen geperforeerde opening voor kraan
Series	Mira		

	Type spoelbak	Afmetingen spoelbak, BxHxD (mm)	Diepte spoelbak (mm)	Hoekradius spoelbak	Overloop spoelbak	Positie crepine spoelbak	Afmeting crepine
Spoelbak	Minimum radius	500 x 400 x 200	200	15	Ja, verzonken	Wandkap	8,89 cm

Technische specificaties



Afmetingen product (mm)	200x540x440 mm	Hoogte vanaf werkblad	1 mm
Afmetingen nis (mm)	525*425 mm	Afmeting inbouwmeubel	60 cm
Cutout dimension undermount (mm)	504*404 mm	Aantal haken	8
Uitsnij radius	17 mm	Type haken	Standard + undermount clip

Meegeleverde accessoires

Accessoires voor
installatie inbegrepen

Crepine, Sifon met
vaatwasseraansluiting,
Montagehaken, Silicone

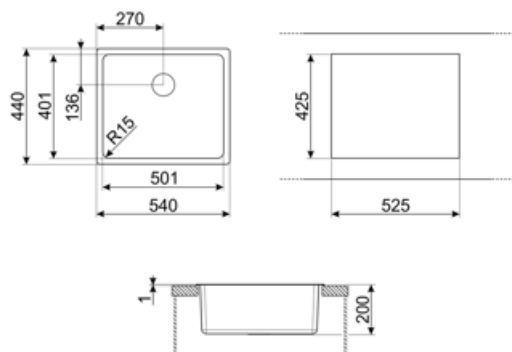

Compatible Accessories



3712

Siphon single bowl sinks (dishwasher connection included)



CB25MN

Single HPE chopping board to fit minimum radius bowls, black matt, measures 250 x 410 H 12 mm, dishwasher safe



COL19H

St/Steel colander to fit MINIMUM radius mm bowl, measures 200 x 410 x 100 mm



DB34

St/steel drain basket to fit STD radius 340 x 400 bowl, 180 mm depth



KITDSQ

Soap dispenser chrome finishing with square knob 40x40 mm



KITFD075

Waste disposal 0,75 HP, Motor: 1/2 horsepower, Fits all sinks with 3 1/2" waste outlet



3713

Siphon double bowls sinks (dishwasher connection included)



COL19

St/Steel colander to fit MINIMUM radius mm bowl, measures 200 x 410 x 26 mm



COL36

St/steel colander for MINIMUM radius bowls, measures 370 x 410 x 30 mm



KITDS

Soap dispenser chrome finishing with round knob



KITFD050

Waste disposal 0,5 HP, Motor: 1/2 horsepower, Fits all sinks with 3 1/2" waste outlet



KITFD100





Waste disposal 1 HP, Motor: 1/2 horsepower, Fits all sinks with 3 1/2" waste outlet



RND1V

Rondò waste kit 1 bowl with standard overflow

Symbols glossary

- | | | | |
|--|---|---|---|
|  | Breedte van het inbouwmeubel voor installatie spoelbak |  | Sink depth - depending on the model, the depth can be from 13 to 24,5. |
|  | Flat: Installation of product with flat edge. |  | Flush-fitted installation: Models of sinks/hobs which are integrated flush with the tabletop of a kitchen unit. |
|  | Under table top installation: The sink is fixed under tabletop, which extends the work surface and the depth of the sink. | | |

Benefit (TT)

One bowl

A single bowl for greater adaptability, capacity and space optimisation