

VFU71SFR

Sink material	Stainless steel
Type	Monoblock bowl
No. of bowls	1
EAN code	8017709304676



Aesthetics



Aesthetic	Universale	Building in type	Flush fitted, Flat, Undermount
Colour	Stainless steel	Logo	Embossed
Finishing	Brushed	Tap hole / precut tap hole	No Taphole
Series	Mira		

	Bowl type	Bowl dimensions, WxDxH (mm)	Bowl depth (mm)	Radius corner bowl	Overflow	Strainer position	Strainer dimension
Bowl	Minimum radius	710 x 400 x 200	200	15	Yes, flush fitted	Wall position	3.5"

Technical Features



Dimensions of the product (mm)	200x750x440 mm	Height from kitchen top	1 mm
Cutout dimension topmount (mm)	735*425 mm	Base unit size	80 cm
Cutout dimension undermount (mm)	712*402 mm	No. of clips	8
Undermount cutout radius	16 mm	Type of clips	Standard + undermount clip

Accessories Included

Accessories for
installation

Strainer, Savespace siphon
with dishwasher outlet
connection, Fixing clips,
Silicone

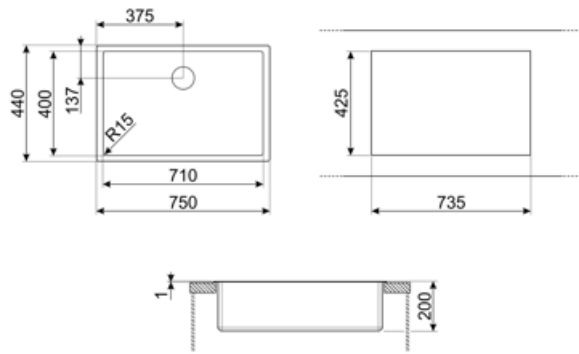

Compatible Accessories



3712

Siphon single bowl sinks (dishwasher connection included)



CB25MN

Single HPE chopping board to fit minimum radius bowls, black matt, measures 250 x 410 H 12 mm, dishwasher safe



COL19H

St/Steel colander to fit MINIMUM radius mm bowl, measures 200 x 410 x 100 mm



DB34

St/steel drain basket to fit STD radius 340 x 400 bowl, 180 mm depth



KITDSQ

Soap dispenser chrome finishing with square knob 40x40 mm



KITFD075

Waste disposal 0,75 HP, Motor: 1/2 horsepower, Fits all sinks with 3 1/2" waste outlet



3713

Siphon double bowls sinks (dishwasher connection included)



COL19

St/Steel colander to fit MINIMUM radius mm bowl, measures 200 x 410 x 26 mm



COL36

St/steel colander for MINIMUM radius bowls, measures 370 x 410 x 30 mm



KITDS

Soap dispenser chrome finishing with round knob



KITFD050

Waste disposal 0,5 HP, Motor: 1/2 horsepower, Fits all sinks with 3 1/2" waste outlet



KITFD100





Waste disposal 1 HP, Motor: 1/2 horsepower, Fits all sinks with 3 1/2" waste outlet



RND1V

Rondò waste kit 1 bowl with standard overflow

Symbols glossary

- | | | | |
|--|---|---|---|
|  | Cupboard width required for sink installation |  | Sink depth - depending on the model, the depth can be from 13 to 24,5 |
|  | Flat: Installation of product with flat edge. |  | Flush-fitted installation: Models of sinks/hobs which are integrated flush with the tabletop of a kitchen unit. |
|  | Under table top installation: The sink is fixed under tabletop, which extends the work surface and the depth of the sink. | | |

Benefit (TT)

One bowl

A single bowl for greater adaptability, capacity and space optimisation