

# VFU71SFR

Sink material	Stainless steel
Type	Monoblock bowl
No. of bowls	1
EAN code	8017709304676



## Aesthetics



<b>Aesthetic</b>	Universale	<b>Building in type</b>	Flush fitted, Flat, Undermount
<b>Colour</b>	Stainless steel	<b>Logo</b>	Embossed
<b>Finishing</b>	Brushed	<b>Tap hole / precut tap hole</b>	No Taphole
<b>Series</b>	Mira		

	Bowl type	Bowl dimensions, WxDxH (mm)	Bowl depth (mm)	Radius corner bowl	Overflow	Strainer position	Strainer dimension
Bowl	Minimum radius	710 x 400 x 200	200	15	Yes, flush fitted	Wall position	3.5"

## Technical Features



<b>Dimensions of the product (mm)</b>	200x750x440 mm	<b>Height from kitchen top</b>	1 mm
<b>Cutout dimension topmount (mm)</b>	735*425 mm	<b>Base unit size</b>	80 cm
<b>Cutout dimension undermount (mm)</b>	712*402 mm	<b>No. of clips</b>	8
<b>Undermount cutout radius</b>	16 mm	<b>Type of clips</b>	Standard + undermount clip

## Accessories included

Accessories for  
installation

Strainer, Savespace siphon  
with dishwasher outlet  
connection, Fixing clips,  
Silicone

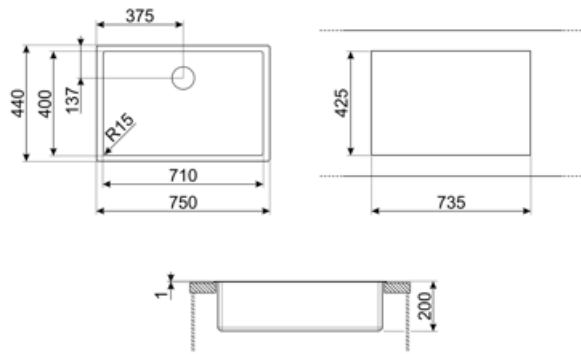

## Compatible Accessories



**3712**

Siphon single bowl sinks (dishwasher connection included)



**CB25MN**

Single HPE chopping board to fit minimum radius bowls, black matt, measures 250 x 410 H 12 mm, dishwasher safe



**COL19H**

St/Steel colander to fit MINIMUM radius mm bowl, measures 200 x 410 x 100 mm



**DB34**

St/steel drain basket to fit STD radius 340 x 400 bowl, 180 mm depth



**KITDSQ**

Soap dispenser chrome finishing with square knob 40x40 mm



**KITFD075**

Waste disposal 0,75 HP, Motor: 1/2 horsepower, Fits all sinks with 3 1/2" waste outlet



**3713**

Siphon double bowls sinks (dishwasher connection included)



**COL19**

St/Steel colander to fit MINIMUM radius mm bowl, measures 200 x 410 x 26 mm



**COL36**

St/steel colander for MINIMUM radius bowls, measures 370 x 410 x 30 mm



**KITDS**

Soap dispenser chrome finishing with round knob



**KITFD050**

Waste disposal 0,5 HP, Motor: 1/2 horsepower, Fits all sinks with 3 1/2" waste outlet



**KITFD100**

Waste disposal 1 HP, Motor: 1/2 horsepower, Fits all sinks with 3 1/2" waste outlet







**RND1V**

Rondò waste kit 1 bowl with standard overflow

---

## Symbols glossary

---

- |  |   |   |   |
|--|---|---|---|
|  | Cupboard width required for sink installation.  |  | Sink depth - depending on the model, the depth can be from 13 to 24,5.  |
|  | Flat: Installation of product with flat edge.   |  | Flush-fitted installation: Models of sinks/hobs which are integrated flush with the tabletop of a kitchen unit. |
|  | Under table top installation: The sink is fixed under tabletop, which extends the work surface and the depth of the sink. |   |   |

---

## Benefit (TT)

---

### **One bowl**

A single bowl for greater adaptability, capacity and space optimisation