

VR12S4040

Sink material	Stainless steel
Type	Welded bowl
No. of bowls	2
Drainer	No
EAN code	8017709308131



Aesthetics



Aesthetic	Universal	Logo	Embossed
Serie	Mira	Alternative colours available	No
Colour	Stainless steel	Half bowl cup drainer	No
Acabamento	Escovado	Tap hole / precut tap hole	No Taphole
Building in type	Flush fitted, Flat, Undermount		

	Bowl type RH	Bowl thickness (mm)	Bowl dimensions, WxDxH (mm)	Bowl depth (mm)	Radius corner right bowl (mm)	Overflow	Strainer position	Strainer dimension
RH Bowl	Minimum radius	1	400 x 400 x 200	200	12	Yes, flush fitted	Wall position	3.5"
LH Bowl	Minimum radius	1	400 x 400 x 200	200	12	Yes, flush fitted	Wall position	3.5"

Technical Features



Frame thickness	1 mm	Popup command	No
Dimensions of the product (mm)	201x840x440 mm	Dividing wall width	25 mm
Cutout dimension topmount (mm)	830*430 mm	Pre-assembled gasket	No
		No. of clips	10
		Type of clips	Clip padrão + subtopo
		Popup command	No

Dimensão do recorte sob a montagem (mm)	800*400 mm
Cutout radius	12 mm
Height from kitchen top	1 mm
Base unit size	90, 100 cm

Accessories Included



Accessories for installation	Strainer, Siphon with dishwasher outlet connection, Fixing clips, Silicone	Basket	No
		Wooden board	No
		White board	No
Colander	No		
Kit integrado de resíduos de descarga	Sim		
Glass board	No		

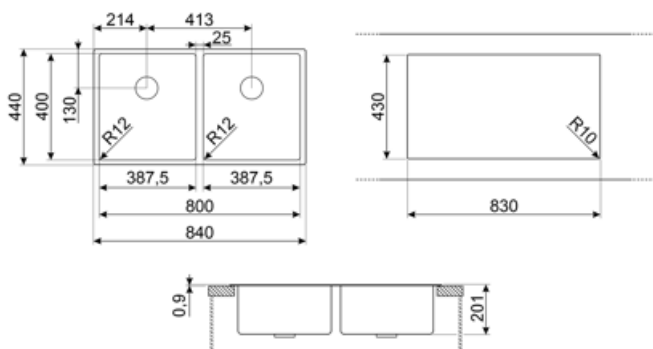

Compatible Accessories



CB25MN

Tábua única de corte HPE para caber em tigelas de raio mínimo, fosca preta, mede 250 x 410 H 12 mm, pode ir à máquina lava-louça



COL19

Coador aço inox para encaixar na tigela de raio MÍNIMO mm, mede 200 x 410 x 26 mm



COL36

Coador de aço para tigelas de raio mínimo, mede 370 x 410 x 30 mm



CB28QU

Tábua única de corte HPL para raio mínimo, carvalho, mede 280 x 418 H 12 mm



COL19H









Coador aço inox para encaixar na tigela de raio MÍNIMO mm, mede 200 x 410 x 100 mm



KITPUSH

1 Pia pop-up automático em AISI304 com botão APENAS para pias com kit de resíduos integrados R12

Symbols glossary

	Largura do armário necessária para a instalação da pia		Largura do armário necessária para a instalação da pia
	Profundidade da pia - dependendo do modelo, a profundidade pode ser de 13 a 24,5		Plana Instalação de produtos com aresta plana.
	Instalação embutida: Modelos de pias/fogões que são integrados nivelados com a mesa de uma unidade de cozinha.		Instalação sob o tampo da mesa: A pia é fixada sob o tampo da mesa, que estende a superfície de trabalho e a profundidade da pia.
	Um exclusivo kit de resíduos totalmente integrado à pia dá um efeito elegante e garante maior higiene com a superfície contínua permitindo combinar comodidade com total segurança durante a preparação dos alimentos. O novo design do plugue é ergonômico e é mais fácil de extrair.		On this sink it is not possible to install the waste disposal

Benefit (TT)

Two bowls

Two bowls for greater versatility and dual functionality

Integrated flush waste kit

Integrated flush waste kit to maximise the efficiency of your kitchen

The fully integrated flush waste kit in stainless steel guarantees hygiene and safety during food preparation as well as giving the sink an elegant appearance