

VR12S4040RS

Sink material	Stainless steel
Type	Welded bowl
No. of bowls	2
Drainer	No
EAN code	8017709308186



Aesthetics



Aesthetic	Universal	Logo	Embossed
Serie	Mira	Alternative colours available	No
Colour	Stainless steel	Half bowl cup drainer	No
Acabamento	Escovado	Tap hole / precut tap hole	2 Tapholes
Building in type	Flush fitted, Flat		

	Bowl type RH	Bowl thickness (mm)	Bowl dimensions, WxDxH (mm)	Bowl depth (mm)	Radius corner right bowl (mm)	Overflow	Strainer position	Strainer dimension
RH Bowl	Minimum radius	1	400 x 400 x 200	200	12	Yes, flush fitted	Wall position	3.5"
LH Bowl	Minimum radius	1	400 x 400 x 200	200	12	Yes, flush fitted	Wall position	3.5"

Technical Features



Frame thickness	1 mm	Popup command	Yes, single
Dimensions of the product (mm)	201x850x510 mm	Popup command type	Empurrar
Cutout dimension topmount (mm)	835*495 mm	Dividing wall width	25 mm
		Pre-assembled gasket	No
Height from kitchen top	1 mm	No. of clips	11
		Type of clips	Undermount clip

Base unit size	90 cm	Popup command	No
Tap hole	2		
Diâmetro do furo da torneira	35 mm		

Accessories Included



Accessories for installation	Strainer, Siphon with dishwasher outlet connection, Fixing clips	Basket	No
Colander	No	Wooden board	No
Kit integrado de resíduos de descarga	Sim	White board	No
Glass board	No		

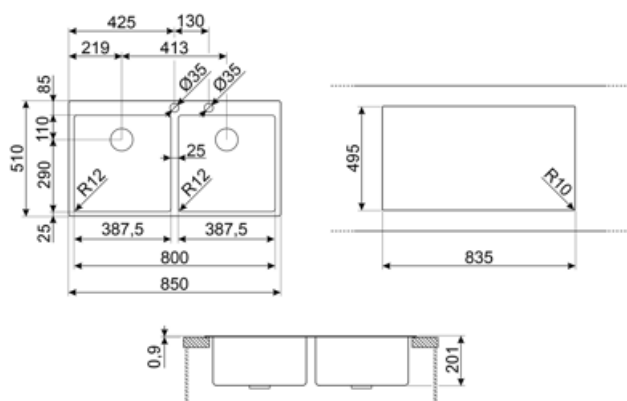

Compatible Accessories



CB25MN

Tábua única de corte HPE para caber em tigelas de raio mínimo, fosca preta, mede 250 x 410 H 12 mm, pode ir à máquina lava-louça



COL19

Coador aço inox para encaixar na tigela de raio MÍNIMO mm, mede 200 x 410 x 26 mm



COL36

Coador de aço para tigelas de raio mínimo, mede 370 x 410 x 30 mm



CB28QU

Tábua única de corte HPL para raio mínimo, carvalho, mede 280 x 418 H 12 mm



COL19H







Coador aço inox para encaixar na tigela de raio MÍNIMO mm, mede 200 x 410 x 100 mm



KITPUSH

1 Pia pop-up automático em AISI304 com botão APENAS para pias com kit de resíduos integrados R12

Symbols glossary

	Largura do armário necessária para a instalação da pia		Profundidade da pia - dependendo do modelo, a profundidade pode ser de 13 a 24,5
	Plana Instalação de produtos com aresta plana.		Instalação embutida: Modelos de pias/fogões que são integrados nivelados com a mesa de uma unidade de cozinha.
	Um exclusivo kit de resíduos totalmente integrado à pia dá um efeito elegante e garante maior higiene com a superfície contínua permitindo combinar comodidade com total segurança durante a preparação dos alimentos. O novo design do plugue é ergonômico e é mais fácil de extrair.		On this sink it is not possible to install the waste disposal

Benefit (TT)

Two bowls

Two bowls for greater versatility and dual functionality

Double tap hole

The sink is easily reversible, making it possible to create any type of kitchen composition

Pop-up command

The pop-up command allows the sink drain to be opened and closed remotely with a simple gesture and without the need to touch the plug directly, increasing convenience and hygiene in the kitchen

Pop-up command push

Attractive and modern pop-up command with push control for greater convenience in the kitchen

With the practical automatic pop-up kit with push control included, one touch is all it takes to control the movement of the drain, which opens and closes automatically ensuring greater convenience and hygiene

Tap hole

Possibility of having the tap hole for direct installation of the tap on the sink, for a larger and neater surface area

Integrated flush waste kit

Integrated flush waste kit to maximise the efficiency of your kitchen

The fully integrated flush waste kit in stainless steel guarantees hygiene and safety during food preparation as well as giving the sink an elegant appearance