

VR12S70

Sink material	Stainless steel
Type	Welded bowl
No. of bowls	1
EAN code	8017709308117



Aesthetics



Aesthetic	Universale	Building in type	Flush fitted, Flat, Undermount
Colour	Stainless steel	Logo	Embossed
Finishing	Brushed	Tap hole / precut tap hole	No Taphole
Series	Mira		

	Bowl type	Bowl dimensions, WxDxH (mm)	Bowl depth (mm)	Radius corner bowl	Overflow	Strainer position	Strainer dimension
Bowl	Minimum radius	700 x 400 x 200	200	12	Yes, flush fitted	Wall position	3.5"

Technical Features

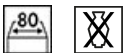

Dimensions of the product (mm)	201x740x440 mm	Base unit size	80, 90 cm
Cutout dimension topmount (mm)	730x430 mm	No. of clips	10
Cutout dimension undermount (mm)	700x400 mm	Type of clips	Standard + undermount clip
Undermount cutout radius	12 mm	Possibility to install waste disposal	No
Height from kitchen top	1 mm		

Accessories included



Accessories for installation

Strainer, Savespace siphon with dishwasher outlet connection, Fixing clips, Silicone

Integrated flush waste kit Yes

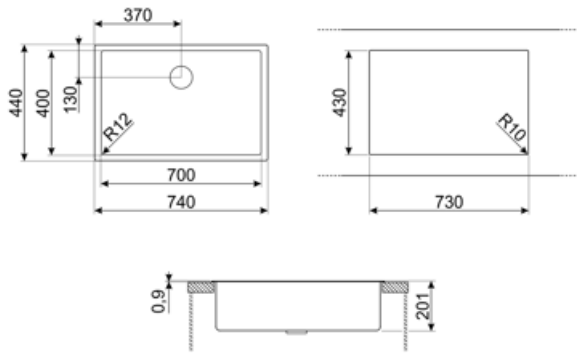

Compatible Accessories



CB25MN

Single HPE chopping board to fit minimum radius bowls, black matt, measures 250 x 410 H 12 mm, dishwasher safe



COL19

St/Steel colander to fit MINIMUM radius mm bowl, measures 200 x 410 x 26 mm



COL36

St/steel colander for MINIMUM radius bowls, measures 370 x 410 x 30 mm



CB28QU

Single HPL chopping board for minimum radius, oak, measures 280 x 418 H 12 mm



COL19H

St/Steel colander to fit MINIMUM radius mm bowl, measures 200 x 410 x 100 mm



KITPUSH

1 Bowl automatic pop up in AISI304 with push button ONLY for integrated waste kit bowls R12

Symbols glossary



Cupboard width required for sink installation.



Flat: Installation of product with flat edge.



Under table top installation: The sink is fixed under tabletop, which extends the work surface and the depth of the sink.



On this sink it is not possible to install the waste disposal



Sink depth - depending on the model, the depth can be from 13 to 24,5.



Flush-fitted installation: Models of sinks/hobs which are integrated flush with the tabletop of a kitchen unit.



A unique waste kit totally integrated with the sink gives an elegant effect and guarantees greater hygiene with the continuous surface allowing you to combine convenience with total safety during the food preparation. The new plug design is ergonomic and it's easier to extract.

Benefit (TT)

One bowl

A single bowl for greater adaptability, capacity and space optimisation

Integrated flush waste kit

Integrated flush waste kit to maximise the efficiency of your kitchen

The fully integrated flush waste kit in stainless steel guarantees hygiene and safety during food preparation as well as giving the sink an elegant appearance.