

VR12S70

Sink material	Stainless steel
Type	Welded bowl
No. of bowls	1
EAN code	8017709308117



Aesthetics



Aesthetic	Universal	Logo	Embossed
Serie	Mira	Alternative colours available	No
Colour	Stainless steel	Half bowl cup drainer	No
Acabamento	Escovado	Tap hole / precut tap hole	No Taphole
Building in type	Flush fitted, Flat, Undermount		

	Bowl type	Bowl dimensions, WxDxH (mm)	Bowl depth (mm)	Radius corner bowl	Overflow	Strainer position	Strainer dimension
Bowl	Minimum radius	700 x 400 x 200	200	12	Yes, flush fitted	Wall position	3.5"

Technical Features

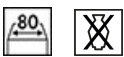

Dimensions of the product (mm)	201x740x440 mm	Tap hole	No
Cutout dimension topmount (mm)	730*430 mm	Popup command	No
Dimensão do recorte sob a montagem (mm)	700*400 mm	Pre-assembled gasket	No
Cutout radius	12 mm	No. of clips	10
Height from kitchen top	1 mm	Type of clips	Clip padrão + subtopo
Base unit size	80, 90 cm	Popup command	No

Accessories Included



Accessories for installation

Strainer, Siphon with dishwasher outlet connection, Fixing clips, Silicone

Glass board

No

Basket

No

Wooden board

No

White board

No

Colander

No

Rondò Cover waste kit

No

Kit integrado de residuos de descarga

Sim

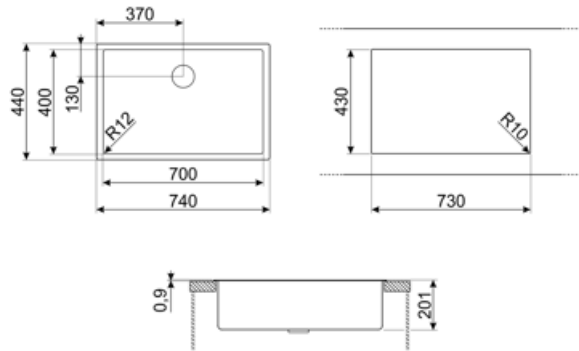

Compatible Accessories



CB25MN

Tábua única de corte HPE para caber em tigelas de raio mínimo, fosca preta, mede 250 x 410 H 12 mm, pode ir à máquina lava-louça



COL19

Coador aço inox para encaixar na tigela de raio MÍNIMO mm, mede 200 x 410 x 26 mm



COL36

Coador de aço para tigelas de raio mínimo, mede 370 x 410 x 30 mm



CB28QU

Tábua única de corte HPL para raio mínimo, carvalho, mede 280 x 418 H 12 mm



COL19H







Coador aço inox para encaixar na tigela de raio MÍNIMO mm, mede 200 x 410 x 100 mm



KITPUSH

1 Pia pop-up automático em AISI304 com botão APENAS para pias com kit de resíduos integrados R12

Symbols glossary

- | | | | |
|--|---|---|--|
|  | Largura do armário necessária para a instalação da pia |  | Profundidade da pia - dependendo do modelo, a profundidade pode ser de 13 a 24,5 |
|  | Plana Instalação de produtos com aresta plana. |  | Instalação embutida: Modelos de pias/fogões que são integrados nivelados com a mesa de uma unidade de cozinha. |
|  | Instalação sob o tampo da mesa: A pia é fixada sob o tampo da mesa, que estende a superfície de trabalho e a profundidade da pia. |  | Um exclusivo kit de resíduos totalmente integrado à pia dá um efeito elegante e garante maior higiene com a superfície contínua permitindo combinar comodidade com total segurança durante a preparação dos alimentos. O novo design do plugue é ergonômico e é mais fácil de extrair. |
|  | On this sink it is not possible to install the waste disposal | | |

Benefit (TT)

One bowl

A single bowl for greater adaptability, capacity and space optimisation

Integrated flush waste kit

Integrated flush waste kit to maximise the efficiency of your kitchen

The fully integrated flush waste kit in stainless steel guarantees hygiene and safety during food preparation as well as giving the sink an elegant appearance