

VR12S70RS

Sink material Stainless steel
 Type Welded bowl
 No. of bowls 1
 EAN code 8017709308162



Aesthetics



Aesthetic	Universale	Building in type	Flush fitted, Flat
Series	Mira	Logo	Embossed
Colour	Stainless steel	Tap hole / precut tap hole	2 Tapholes
Finishing	Brushed		

	Bowl type	Bowl dimensions, WxDxH (mm)	Bowl depth (mm)	Radius corner bowl	Overflow	Strainer position	Strainer dimension
Bowl	Minimum radius	700 x 400 x 200	200	12	Yes, flush fitted	Wall position	3.5"

Technical Features



Dimensions of the product (mm)	201x750x510 mm	Tap hole diameter	35 mm
Cutout dimension topmount (mm)	735*495 mm	Popup command	Yes, single
Height from kitchen top	1 mm	Popup command type	Push
Base unit size	80 cm	No. of clips	11
Tap hole	2	Type of clips	Standard

Accessories Included



Accessories for installation

Strainer, Savespace siphon with dishwasher outlet connection, Fixing clips, Automatic pop-up with push control

Integrated flush waste kit Yes

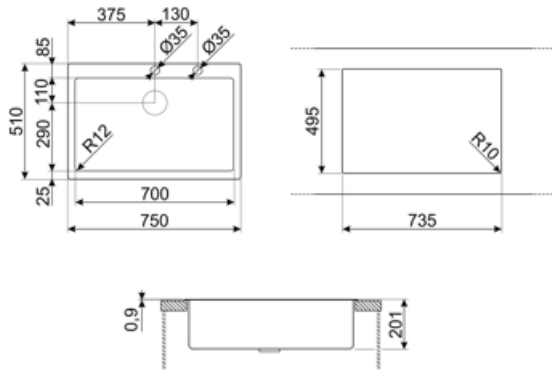

Compatible Accessories



CB25MN

Single HPE chopping board to fit minimum radius bowls, black matt, measures 250 x 410 H 12 mm, dishwasher safe



COL19

St/Steel colander to fit MINIMUM radius mm bowl, measures 200 x 410 x 26 mm



COL36

St/steel colander for MINIMUM radius bowls, measures 370 x 410 x 30 mm



CB28QU

Single HPL chopping board for minimum radius, oak, measures 280 x 418 H 12 mm



COL19H

St/Steel colander to fit MINIMUM radius mm bowl, measures 200 x 410 x 100 mm



KITPUSH

1 Bowl automatic pop up in AISI304 with push button ONLY for integrated waste kit bowls R12

Symbols glossary



Cupboard width required for sink installation



Flat: Installation of product with flat edge.



A unique waste kit totally integrated with the sink gives an elegant effect and guarantees greater hygiene with the continuous surface allowing you to combine convenience with total safety during the food preparation. The new plug design is ergonomic and it's easier to extract.



Sink depth - depending on the model, the depth can be from 13 to 24,5



Flush-fitted installation: Models of sinks/hobs which are integrated flush with the tabletop of a kitchen unit.



On this sink it is not possible to install the waste disposal

Benefit (TT)

One bowl

A single bowl for greater adaptability, capacity and space optimisation

Double tap hole

The sink is easily reversible, making it possible to create any type of kitchen composition

Pop-up command

The pop-up command allows the sink drain to be opened and closed remotely with a simple gesture and without the need to touch the plug directly, increasing convenience and hygiene in the kitchen

Pop-up command push

Attractive and modern pop-up command with push control for greater convenience in the kitchen

With the practical automatic pop-up kit with push control included, one touch is all it takes to control the movement of the drain, which opens and closes automatically ensuring greater convenience and hygiene

Tap hole

Possibility of having the tap hole for direct installation of the tap on the sink, for a larger and neater surface area

Integrated flush waste kit

Integrated flush waste kit to maximise the efficiency of your kitchen

The fully integrated flush waste kit in stainless steel guarantees hygiene and safety during food preparation as well as giving the sink an elegant appearance