

# VR12S70RS

Sink material	Stainless steel
Type	Welded bowl
No. of bowls	1
EAN code	8017709308162

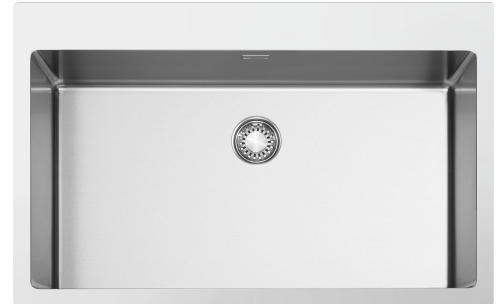

## Aesthetics



Aesthetic	Universal	Logo	Embossed
Serie	Mira	Alternative colours available	No
Colour	Stainless steel	Half bowl cup drainer	No
Acabamento	Escovado	Tap hole / precut tap hole	2 Tapholes
Building in type	Flush fitted, Flat		

	Bowl type	Bowl dimensions, WxDxH (mm)	Bowl depth (mm)	Radius corner bowl	Overflow	Strainer position	Strainer dimension
Bowl	Minimum radius	700 x 400 x 200	200	12	Yes, flush fitted	Wall position	3.5"

## Technical Features

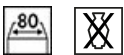

Dimensions of the product (mm)	201x750x510 mm	Popup command	Yes, single
Cutout dimension topmount (mm)	735*495 mm	Popup command type	Empurrar
Height from kitchen top	1 mm	Pre-assembled gasket	No
Base unit size	80 cm	No. of clips	11
Tap hole	2	Type of clips	Standard
Diâmetro do furo da torneira	35 mm	Popup command	No

## Accessories Included



**Accessories for installation**

Strainer, Siphon with dishwasher outlet connection, Fixing clips, Pop-up automático com controle push

**Glass board**

No

**Basket**

No

**Wooden board**

No

**White board**

No

**Colander**

No

**Rondò Cover waste kit**

No

**Kit integrado de resíduos de descarga**

Sim

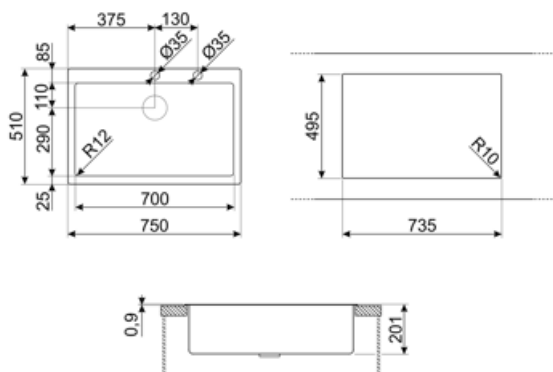

## Compatible Accessories



### CB25MN

Tábua única de corte HPE para caber em tigelas de raio mínimo, fosca preta, mede 250 x 410 H 12 mm, pode ir à máquina lava-louça



### COL19

Coador aço inox para encaixar na tigela de raio MÍNIMO mm, mede 200 x 410 x 26 mm



### COL36

Coador de aço para tigelas de raio mínimo, mede 370 x 410 x 30 mm



### CB28QU

Tábua única de corte HPL para raio mínimo, carvalho, mede 280 x 418 H 12 mm



### COL19H

Coador aço inox para encaixar na tigela de raio MÍNIMO mm, mede 200 x 410 x 100 mm









### KITPUSH

1 Pia pop-up automático em AISI304 com botão APENAS para pias com kit de resíduos integrados R12

---

## Symbols glossary

---

	Largura do armário necessária para a instalação da pia		Profundidade da pia - dependendo do modelo, a profundidade pode ser de 13 a 24,5
	Plana Instalação de produtos com aresta plana.		Instalação embutida: Modelos de pias/fogões que são integrados nivelados com a mesa de uma unidade de cozinha.
	Um exclusivo kit de resíduos totalmente integrado à pia dá um efeito elegante e garante maior higiene com a superfície contínua permitindo combinar comodidade com total segurança durante a preparação dos alimentos. O novo design do plugue é ergonômico e é mais fácil de extrair.		On this sink it is not possible to install the waste disposal

---

## Benefit (TT)

---

### **One bowl**

A single bowl for greater adaptability, capacity and space optimisation

### **Double tap hole**

The sink is easily reversible, making it possible to create any type of kitchen composition

### **Pop-up command**

The pop-up command allows the sink drain to be opened and closed remotely with a simple gesture and without the need to touch the plug directly, increasing convenience and hygiene in the kitchen

### **Pop-up command push**

Attractive and modern pop-up command with push control for greater convenience in the kitchen

With the practical automatic pop-up kit with push control included, one touch is all it takes to control the movement of the drain, which opens and closes automatically ensuring greater convenience and hygiene

### **Tap hole**

Possibility of having the tap hole for direct installation of the tap on the sink, for a larger and neater surface area

### **Integrated flush waste kit**

Integrated flush waste kit to maximise the efficiency of your kitchen

The fully integrated flush waste kit in stainless steel guarantees hygiene and safety during food preparation as well as giving the sink an elegant appearance