

VSGX860B

Sink material	Composite
Type	Synthetic bowl
No. of bowls	1
Drainer	No
EAN code	8017709282370



Aesthetics



Aesthetic	Universal	Logo	Applied
Serie	Quadra	Alternative colours available	Black, Cemento / Concrete
Colour	White	Half bowl cup drainer	No
Building in type	Standard	Tap hole / precut tap hole	Prepared

	Bowl type RH	Bowl dimensions, WxDxH (mm)	Bowl depth (mm)	Radius corner right bowl (mm)	Overflow	Strainer position	Strainer dimension
RH Bowl	Minimum radius	796 x 386 x 215	215	6	Yes, flush fitted	Wall position	3.5"

Technical Features



Características do material composto

Válvula de escoamento, Fácil de limpar, Sifão com ligação à máquina de lavar louça, Resistente a choques térmicos, Ganchos de fixação, Vedantes, Resistente a UV

Frame depth (mm)

5

Dimensions of the product (mm)

215x860x510 mm

Tap hole

1

Diâmetro do furo da torneira

35 mm

Popup command

No

Pre-assembled gasket

No

No. of clips

8

Type of clips

Standard

Cutout dimension topmount (mm)	840 x 480 mm
Height from kitchen top	10 mm
Base unit size	90 cm

Accessories Included

Accessories for installation	Strainer, Siphon with dishwasher outlet connection, Fixing clips	Basket	No
Colander	No	Tábua de corte de carvalho HPL	Yes
Rondò Cover waste kit	No	White board	No
Glass board	No		

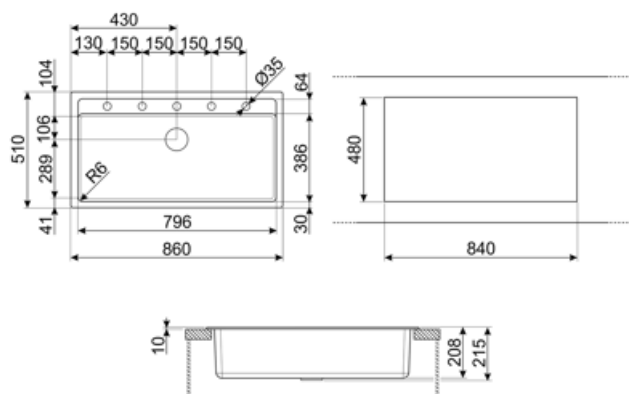

Compatible Accessories



CB25MN

Tábua única de corte HPE para caber em tigelas de raio mínimo, fosca preta, mede 250 x 410 H 12 mm, pode ir à máquina lava-louça



COL19H

Coador aço inox para encaixar na tigela de raio MÍNIMO mm, mede 200 x 410 x 100 mm



KITDSQ

Botão quadrado do dispensador de sabão



KITFD075

Eliminação de resíduos 0,75 CV Motor: 3/4 CV Adapta-se a todas as pias com saída de resíduos de 3 1/2"



COL19

Coador aço inox para encaixar na tigela de raio MÍNIMO mm, mede 200 x 410 x 26 mm



COL36

Coador de aço para tigelas de raio mínimo, mede 370 x 410 x 30 mm



KITFD050











Eliminação de resíduos 0,5 CV Motor: 1/2 cv Serve para todas as pias com saída de resíduos de 3 1/2"



KITFD100

Eliminação de resíduos 1 CV Motor: 1 cv Serve para todas as pias com saída de resíduos de 3 1/2"

Symbols glossary

	Antisséptico		Antirrisco
	Largura do armário necessária para a instalação da pia		Profundidade da pia - dependendo do modelo, a profundidade pode ser de 13 a 24,5
	Instalação padrão: Instalação tradicional em tampo de mesa, adequado para qualquer conjunto de cozinha		Fácil de limpar
	Resistente a choques térmicos		Resistente a altas temperaturas
	Resistente a impactos		A proteção UV, não se desvanece com o tempo.

Benefit (TT)

One bowl

A single bowl for greater adaptability, capacity and space optimisation

Tap hole possibility

Possibility of having the tap hole for direct installation of the tap on the sink, for a larger and neater surface area

Oak board

Cutting board included for efficient use of available space