

VSGX860CT

Materiale	Composito
Tipologia	Vasca composito
Numero vasche	1
Codice EAN	8017709282387



Estetica



Serie	Quadra	Logo	Applicato
Estetica	Universale	Altri colori disponibili	Nero, Bianco
Colore	Cemento	Forato / predisposto per foratura	Predisp.
Tipo incasso	Standard		

	Tipologia vasca dx	Dimensioni vasca dx, L x P x A (mm)	Profondità vasca dx (mm)	Raggio angolare vasca dx	Trooppieno vasca	Posizione scarico vasca	Dimensione scarico vasca
Vasca dx	Raggiata	796 x 386 x 215	215	6	Si, perimetrale	A parete	3.5"

Caratteristiche Tecniche



Caratteristiche materiale composito	Antibatterico, Antigraffio, Resistente agli shock termici, Resistente alle temperature elevate, Resistente agli urti, Facile da pulire, Resistente ai raggi UV	Misura mobile incasso	90 cm
Profondità invaso (mm)	5	Foro miscelatore	1
Dimensioni del prodotto (mm)	215x860x510 mm	Diametro foro miscelatore	35 mm
Dimensioni foro incasso sopratop (mm)	840 x 480 mm	Numero ganci	8
		Tipologia ganci	Standard

Raggio angolare foro incasso sottotop 15 mm
 Altezza da top cucina 10 mm

Dotazione Accessori Inclusi

Dotazione accessori montaggio	Piletta, Sifone salvaspazio con attacco lavastoviglie, Ganci montaggio	Tagliere HPL quercia	Sì
-------------------------------	------------------------------------------------------------------------	----------------------	----

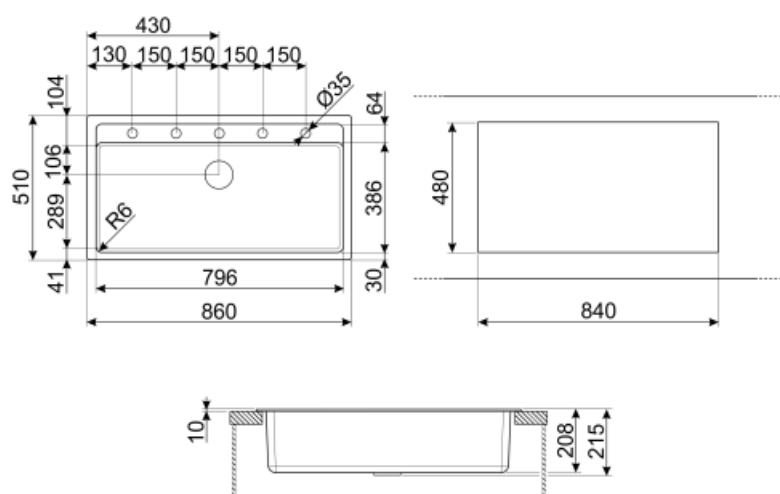

Accessori non inclusi



KITFD050

Tritarifiuti 0,5 HP, Motore: 1/2 potenza, Adatto a tutti i lavelli con scarico da 3 1/2 "



KITFD100

Tritarifiuti 1 HP, Motore: 1/2 potenza, Adatto a tutti i lavelli con scarico da 3 1/2 "



COL19

Scolapasta in acciaio per vasca raggio MINIMO, misure 200 x 410 x 26 mm



CB25MN

Tagliere singolo in HPE adatto per vasca raggio minimo, nero opaco, misure 250 x 410 H 12 mm, lavabile in lavastoviglie



KITFD050UK

Tritarifiuti 0,5 HP, Motore: 1/2 potenza, Adatto a tutti i lavelli con scarico da 3 1/2 ", UK



COL36

Scolapasta in acciaio per vasca raggio MINIMO, misure 370 x 410 x 30 mm



COL19H

Scolapasta in acciaio per vasca raggio MINIMO, misure 200 x 410 x 100 mm



KITDSQ











Dispenser di sapone finitura cromata con manopola quadrata 40x40 mm



KITFD075

Tritarifiuti 0,75 HP, Motore: 1/2 potenza, Adatto a tutti i lavelli con scarico da 3 1/2 "

Glossario simboli

	Dimensione del mobile base: Dimensione del mobile base necessaria per l'installazione del lavello.		Indica la profondità della vasca.
	Standard: modalità di installazione, che si abbina facilmente a qualsiasi tipo di cucina.		Antibatterico
	Antigraffio		Resistente agli shock termici
	Resistente alle temperature elevate		Resistente agli urti
	Facile da pulire		Protezione UV, non scolorisce nel tempo.