

VSTR34CUX

Materiaal	Inox
Type spoelbak	Enkel geperste spoelbak
Aantal spoelbakken	1
EAN-code	8017709276836



Design



Design	Universeel	Type inbouw	Onderbouw
Kleur	Koper	Logo	In reliëf
Afwerking	PVD Brushed	Geperforeerde opening voor kraan	Geen geperforeerde opening voor kraan
Series	Mira		

	Type spoelbak	Afmetingen spoelbak, BxHxD (mm)	Diepte spoelbak (mm)	Hoekradius spoelbak	Overloop spoelbak	Positie crepine spoelbak	Afmeting crepine
Spoelbak	Minimum radius	340 x 400 x 200	200	15	Ja, verzonken	Wandkap	8,89 cm

Technische specificaties



Characteristics PVD coating	Coating thickness , Eco-friendly, Easy to clean, Hypoallergenic	Diameter kraangat	35 mm
Afmetingen product (mm)	200x382x442 mm	Aantal haken	4
Cutout dimension undermount (mm)	344*404 mm	Type haken	Onderbouw haken
Afmeting inbouwmeubel	45 cm		

Meegeleverde accessoires

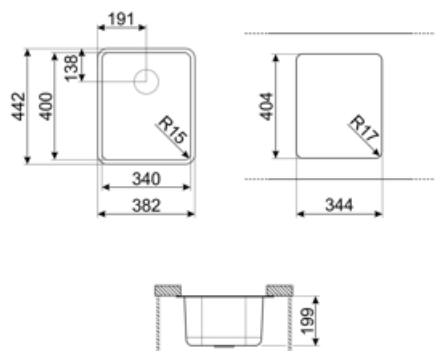

Compatible Accessories



3712

Siphon single bowl sinks (dishwasher connection included)



DB34

St/steel drain basket to fit STD radius
340 x 400 bowl, 180 mm depth



KITFD075

Waste disposal 0,75 HP, Motor: 1/2
horsepower, Fits all sinks with 3 1/2"
waste outlet



3713

Siphon double bowls sinks
(dishwasher connection included)



KITFD050

Waste disposal 0,5 HP, Motor: 1/2
horsepower, Fits all sinks with 3 1/2"
waste outlet



KITFD100

Waste disposal 1 HP, Motor: 1/2
horsepower, Fits all sinks with 3 1/2"
waste outlet

Alternative products



VSTR34DKX







Kleur: Dark Inox



VSTR34BRX

Kleur: Messing

Symbols glossary

- | | | | |
|----------------------------------------------------------------------------------|---------------------------------------------------------------------------------------------------------------------------|-----------------------------------------------------------------------------------|---------------------------------------------------------------------------|
|  | Cupboard width required for sink installation. |  | Sink depth - depending on the model, the depth can be from 13 to 24,5. |
|  | Under table top installation: The sink is fixed under tabletop, which extends the work surface and the depth of the sink. |  | Coating thickness between 0.2mm and 2mm |
|  | Easy to clean |  | The manufacturing process of PVD treatment is 100% green and eco-friendly |
|  | PVD coatings are hypoallergenic and suitable for use in contact with food | | |

Benefit (TT)

One bowl

A single bowl for greater adaptability, capacity and space optimisation