

# VSTR34CUX

Material do lava louça  
 Tipo de lava louça  
 N° de cubas  
 Código EAN

Aço inox  
 Cuba monoestampada  
 1  
 8017709276836



## Design



Design	Universal	Instalação	Instalação inferior
Design	Série Mira	Logótipo	Logótipo embutido
Cor	Cor de cobre	Furo para a misturadora	Lava louça sem furo para misturadora
Acabamentos	PVD Brushed		

	Tipo de cuba	Dimensões da cuba, LxPxA	Profundidade da cuba (mm)	Raio angular da cuba	Furo de escoamento de excesso de água	Posição da válvula de escoamento	Diâmetro da válvula de escoamento
Cuba	Cuba com cantos Radius	340 x 400 x 200	200	15	Furo de escoamento de excesso de água plano	Válvula de escoamento à parede	Válvula de escoamento ø 3.5"

## Especificações técnicas



Characteristics PVD coating	Coating thickness , Eco-friendly, Easy to clean, Hypoallergenic	Ø do furo da misturadora	35 mm
Dimensões do produto (mm)	200x382x442 mm	Número de ganchos de fixação	4
Dimensão do recorte sob a superfície	344*404 mm	Tipologia de ganchos de fixação	Ganchos para instalação inferior
Medida do móvel de encastre	45 cm		

## Acessórios incluídos

Fornecido com  
acessórios para  
instalação

Válvula de escoamento,  
Ganchos de fixação

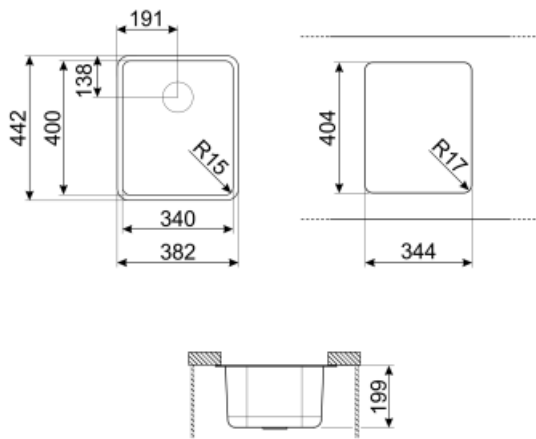

---

## Not included accessories

---



### KITFD050

Waste disposal 0,5 HP, Motor: 1/2 horsepower, Fits all sinks with 3 1/2" waste outlet



### KITFD100

Waste disposal 1 HP, Motor: 1/2 horsepower, Fits all sinks with 3 1/2" waste outlet



### DB34

St/steel drain basket to fit STD radius 340 x 400 bowl, 180 mm depth



### 3712

Siphon single bowl sinks (dishwasher connection included)



### 3713

Siphon double bowls sinks (dishwasher connection included)









### KITFD075

Waste disposal 0,75 HP, Motor: 1/2 horsepower, Fits all sinks with 3 1/2" waste outlet

---

## Symbols glossary (TT)

---

- |  |  |   |  |
|--|--|---|--|
|  | Identifica a largura mínima, em centímetros, necessária no móvel para instalar o lava-louça  |  | Altura da cuba: Permite ter uma perceção da capacidade para receber louça. |
|  | O lava-louça é instalado debaixo da bancada, maximizando toda a bancada disponível. Esta solução é designada como cuba porque não inclui o escorredor. |  | Easy to clean  |
|  | Coating thickness between 0.2mm and 2mm  |  | PVD coatings are hypoallergenic and suitable for use in contact with food  |
|  | The manufacturing process of PVD treatment is 100% green and eco-friendly  |   |  |