

# VSTR40CUX

Material do lava louça  
Tipo de lava louça  
N° de cubas  
Código EAN

Aço inox  
Cuba monoestampada  
1  
8017709276843



## Design



Design	Universal	Instalação	Instalação inferior
Design	Série Mira	Logótipo	Logótipo embutido
Cor	Cor de cobre	Furo para a misturadora	Lava louça sem furo para misturadora
Acabamentos	PVD Brushed		

	Tipo de cuba	Dimensões da cuba, LxPxA	Profundidade da cuba (mm)	Raio angular da cuba	Furo de escoamento de excesso de água	Posição da válvula de escoamento	Diâmetro da válvula de escoamento
Cuba	Cuba com cantos Radius	400 x 400 x 200	200	15	Furo de escoamento de excesso de água plano	Válvula de escoamento à parede	Válvula de escoamento ø 3.5"

## Especificações técnicas



Characteristics PVD coating	Coating thickness , Eco-friendly, Easy to clean, Hypoallergenic	Ø do furo da misturadora	35 mm
Dimensões do produto (mm)	200x440x440 mm	Número de ganchos de fixação	8
Dimensão do recorte sob a superfície	404*404 mm	Tipologia de ganchos de fixação	Ganchos para instalação inferior
Medida do móvel de encastre	60 cm		

## Acessórios incluídos

Fornecido com  
acessórios para  
instalação

Válvula de escoamento,  
Sifão com ligação à  
máquina de lavar louça,  
Ganchos de fixação

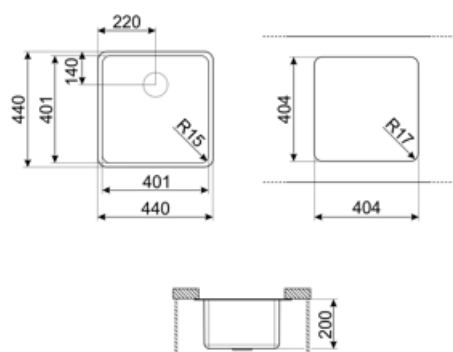

---

## Acessórios Compatíveis

---



**3712**

Siphon single bowl sinks (dishwasher connection included)



**3713**

Siphon double bowls sinks (dishwasher connection included)



**DB34**

St/steel drain basket to fit STD radius  
340 x 400 bowl, 180 mm depth



**KITFD050**

Waste disposal 0,5 HP, Motor: 1/2  
horsepower, Fits all sinks with 3 1/2"  
waste outlet



**KITFD075**







Waste disposal 0,75 HP, Motor: 1/2  
horsepower, Fits all sinks with 3 1/2"  
waste outlet



**KITFD100**

Waste disposal 1 HP, Motor: 1/2  
horsepower, Fits all sinks with 3 1/2"  
waste outlet

## Symbols glossary

	Identifica a largura mínima, em centímetros, necessária no móvel para instalar o lava-louça		Altura da cuba: Permite ter uma perceção da capacidade para receber louça.
	O lava-louça é instalado debaixo da bancada, maximizando toda a bancada disponível. Esta solução é designada como cuba porque não inclui o escorredor.		Easy to clean
	Coating thickness between 0.2mm and 2mm		PVD coatings are hypoallergenic and suitable for use in contact with food
	The manufacturing process of PVD treatment is 100% green and eco-friendly		

---

## Benefit (TT)

---

### **One bowl**

A single bowl for greater adaptability, capacity and space optimisation