

VSTR50CUX

Sink material	Stainless steel
Type	Monoblock bowl
No. of bowls	1
EAN code	8017709276850



Aesthetics



Aesthetic	Universal	Logo	Embossed
Serie	Mira	Alternative colours available	No
Colour	Copper	Half bowl cup drainer	No
Acabamento	PVD Escovado	Tap hole / precut tap hole	No Taphole
Building in type	Undermount		

	Bowl type	Bowl dimensions, WxDxH (mm)	Bowl depth (mm)	Radius corner bowl	Overflow	Strainer position	Strainer dimension
Bowl	Minimum radius	500 x 400 x 200	200	15	Yes, flush fitted	Wall position	3.5"

Technical Features



Características Revestimento PVD	Espessura de revestimento, Ecológico, Fácil de limpar, hipoalergênico	Diâmetro do furo da torneira	35 mm
Dimensions of the product (mm)	200x542x442 mm	Popup command	No
Dimensão do recorte sob a montagem (mm)	404*504 mm	Pre-assembled gasket	No
Base unit size	60 cm	No. of clips	8
Tap hole	No	Type of clips	Undermount clip

Accessories Included

Accessories for installation	Strainer, Siphon with dishwasher outlet connection, Fixing clips	Basket	No
		Wooden board	No
		White board	No
Colander	No		
Rondò Cover waste kit	No		
Glass board	No		

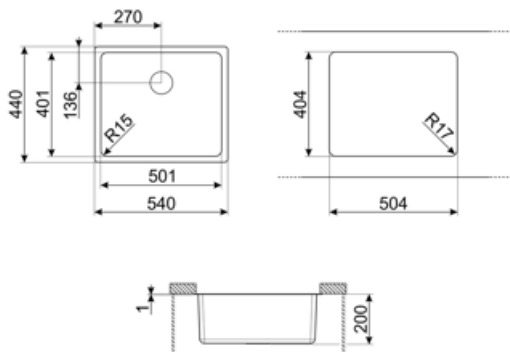

Compatible Accessories



3712

Pias de bacia única sifão (conexão da máquina lava-louça incluída)



DB34

Cesto de fio inox para acoplar às pias com dimensões de 340*400 mm



KITFD075

Eliminação de resíduos 0,75 CV Motor: 3/4 CV Adapta-se a todas as pias com saída de resíduos de 3 1/2"



3713

Sifão bacias duplas pias (conexão da máquina lava-louça incluída)



KITFD050







Eliminação de resíduos 0,5 CV Motor: 1/2 cv Serve para todas as pias com saída de resíduos de 3 1/2"



KITFD100

Eliminação de resíduos 1 CV Motor: 1 cv Serve para todas as pias com saída de resíduos de 3 1/2"

Symbols glossary

- | | | | |
|--|---|---|--|
|  | Largura do armário necessária para a instalação da pia |  | Profundidade da pia - dependendo do modelo, a profundidade pode ser de 13 a 24,5 |
|  | Instalação sob o tampo da mesa: A pia é fixada sob o tampo da mesa, que estende a superfície de trabalho e a profundidade da pia. |  | Espessura do revestimento entre 0,2mm e 2mm |
|  | Fácil de limpar |  | O processo de fabricação do tratamento PVD é 100% verde e ecologicamente correto |
|  | Os revestimentos PVD são hipoalergênicos e adequados para uso em contato com alimentos | | |

Benefit (TT)

One bowl

A single bowl for greater adaptability, capacity and space optimisation