

VSTR50DKX

Sink material	Stainless steel
Type	Monoblock bowl
No. of bowls	1
EAN code	8017709276812



Aesthetics



Aesthetic	Universale	Building in type	Undermount
Colour	Dark Inox	Logo	Embossed
Finishing	PVD Brushed	Tap hole / precut tap hole	No Taphole
Series	Mira		

	Bowl type	Bowl dimensions, WxDxH (mm)	Bowl depth (mm)	Radius corner bowl	Overflow	Strainer position	Strainer dimension
Bowl	Minimum radius	500 x 400 x 200	200	15	Yes, flush fitted	Wall position	3.5"

Technical Features



Characteristics PVD coating	Coating thickness , Eco-friendly, Easy to clean, Hypoallergenic	Tap hole diameter	35 mm
Dimensions of the product (mm)	200x542x442 mm	No. of clips	8
Cutout dimension undermount (mm)	404*504 mm	Type of clips	Undermount clip
Base unit size	60 cm		

Accessories included

Accessories for
installation

Strainer, Savespace siphon
with dishwasher outlet
connection, Fixing clips

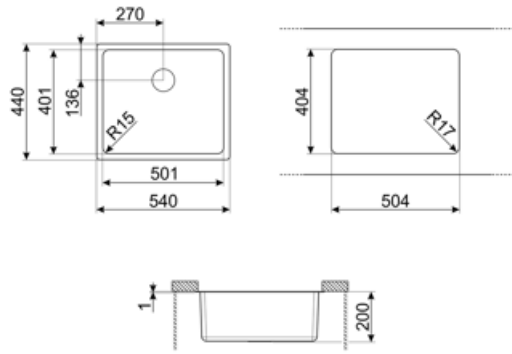

Compatible Accessories



3712

Siphon single bowl sinks (dishwasher connection included)



3713

Siphon double bowls sinks (dishwasher connection included)



DB34

St/steel drain basket to fit STD radius
340 x 400 bowl, 180 mm depth



KITFD050

Waste disposal 0,5 HP, Motor: 1/2 horsepower, Fits all sinks with 3 1/2" waste outlet



KITFD075

Waste disposal 0,75 HP, Motor: 1/2 horsepower, Fits all sinks with 3 1/2" waste outlet



KITFD100

Waste disposal 1 HP, Motor: 1/2 horsepower, Fits all sinks with 3 1/2" waste outlet

Alternative products



VSTR50CUX







Colour: Copper



VSTR50BRX

Colour: Brass

Symbols glossary

- | | | | |
|--|---|---|---|
|  | Cupboard width required for sink installation. |  | Sink depth - depending on the model, the depth can be from 13 to 24,5. |
|  | Under table top installation: The sink is fixed under tabletop, which extends the work surface and the depth of the sink. |  | Easy to clean |
|  | Coating thickness between 0.2mm and 2mm |  | PVD coatings are hypoallergenic and suitable for use in contact with food |
|  | The manufacturing process of PVD treatment is 100% green and eco-friendly | | |

Benefit (TT)

One bowl

A single bowl for greater adaptability, capacity and space optimisation