

# VZ3434B

Sink material	Composite
Type	Synthetic sink
No. of bowls	2
Drainer	No
EAN code	8017709213558



## Aesthetics



<b>Aesthetic</b>	Universal	<b>Logo</b>	Applied/on overflow
<b>Serie</b>	Quadra	<b>Alternative colours available</b>	Black, Cream, Beige, Cemento / Concrete, EXTRA White, EXTRA Black
<b>Colour</b>	White	<b>Half bowl cup drainer</b>	No
<b>Building in type</b>	Standard	<b>Tap hole / precut tap hole</b>	Prepared

	Bowl type RH	Bowl dimensions, WxDxH (mm)	Bowl depth (mm)	Radius corner right bowl (mm)	Overflow	Strainer position	Strainer dimension
RH Bowl	Minimum radius	343 x 395 x 220	220	5	No	Wall position	3.5"
LH Bowl	Minimum radius	343 x 395 x 220	220	5	Yes, traditional	Side bowl	3.5"

## Technical Features



### Características do material composto

Válvula de escoamento, Fácil de limpar, Sifão com ligação à máquina de lavar louça, Resistente a choques térmicos, Ganchos de fixação, Vedantes, Resistente a UV

<b>Tap hole</b>	1
<b>Diâmetro do furo da torneira</b>	35 mm
<b>Popup command</b>	No
<b>Dividing wall width</b>	34 mm

Frame depth (mm)	10	Pre-assembled gasket	No
Dimensions of the product (mm)	235x790x500 mm	No. of clips	4
Cutout dimension topmount (mm)	770 X 480 mm	Type of clips	Standard
Cutout radius	10 mm		
Height from kitchen top	10 mm		
Base unit size	80 cm		

## Accessories Included

Accessories for installation	Strainer, Siphon with dishwasher outlet connection, Fixing clips	Basket	No
Colander	No	Wooden board	No
Rondò Cover waste kit	No	White board	No
Glass board	No		

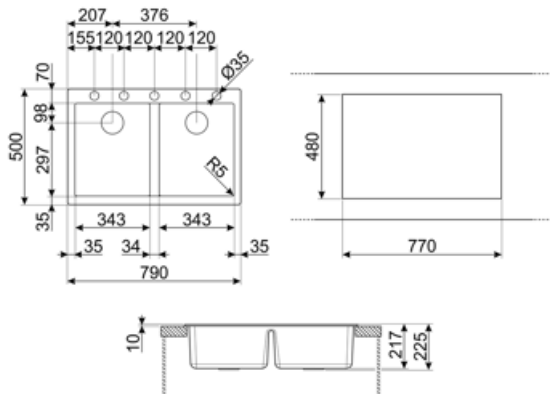

## Compatible Accessories



### CB28QU

Tábua única de corte HPL para raio mínimo, carvalho, mede 280 x 418 H 12 mm



### KITDSQ

Botão quadrado do dispensador de sabão



### KITFD075

Eliminação de resíduos 0,75 CV Motor: 3/4 CV Adapta-se a todas as pias com saída de resíduos de 3 1/2"



### COL36

Coador de aço para tigelas de raio mínimo, mede 370 x 410 x 30 mm



### KITFD050











Eliminação de resíduos 0,5 CV Motor: 1/2 cv Serve para todas as pias com saída de resíduos de 3 1/2"



### KITFD100

Eliminação de resíduos 1 CV Motor: 1 cv Serve para todas as pias com saída de resíduos de 3 1/2"

## Symbols glossary

	Largura do armário necessária para a instalação da pia		Profundidade da pia - dependendo do modelo, a profundidade pode ser de 13 a 24,5
	Instalação padrão: Instalação tradicional em tampo de mesa, adequado para qualquer conjunto de cozinha		Antisséptico
	Antirrisco		Resistente a choques térmicos
	Resistente a altas temperaturas		Resistente a impactos
	Fácil de limpar		A proteção UV, não se desvanece com o tempo.

---

## Benefit (TT)

---

### **Two bowls**

Two bowls for greater versatility and dual functionality

### **Tap hole possibility**

Possibility of having the tap hole for direct installation of the tap on the sink, for a larger and neater surface area