

# VZ3434N

**Sink material** Composite  
**Type** Composite sink  
**No. of bowls** 2  
**EAN code** 8017709213565



## Aesthetics



<b>Aesthetic</b>	Universale	<b>Logo</b>	Applied/on overflow
<b>Colour</b>	Black	<b>Alternative colours available</b>	White, Cream, Beige, Cemento / Concrete, EXTRA White, EXTRA Black
<b>Series</b>	Quadra	<b>Tap hole / precut tap hole</b>	Prepared
<b>Building in type</b>	Standard		

	Bowl type RH	Bowl dimensions, WxDxH (mm)	Bowl depth (mm)	Radius corner right bowl (mm)	Overflow LH bowl	Strainer position	Strainer dimension
RH Bowl	Minimum radius	343 x 395 x 220	220	5		Wall position	3.5"
LH Bowl	Minimum radius	343 x 395 x 220	220	5	Yes, traditional	Side bowl	3.5"

## Technical Features



<b>Characteristics composite material</b>	Antibacterial, Easy to clean, Anti-scratch, Thermal shock resistant, High temperatures resistant, Impact resistant, UV Resistant	<b>Base unit size</b>	80 cm
<b>Frame depth (mm)</b>	10	<b>Tap hole</b>	1
		<b>Tap hole diameter</b>	35 mm
		<b>Dividing wall width</b>	34 mm
		<b>No. of clips</b>	4
		<b>Type of clips</b>	Standard

Dimensions of the product (mm)	235x790x500 mm
Cutout dimension topmount (mm)	770 X 480 mm
Undermount cutout radius	10 mm
Height from kitchen top	10 mm

## Accessories included

Accessories for installation	Strainer, Savespace siphon with dishwasher outlet connection, Fixing clips
------------------------------	--

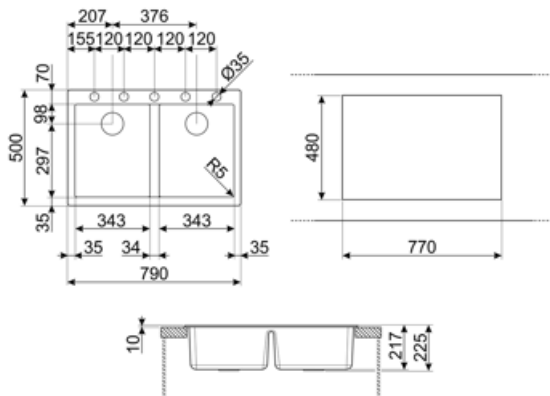

---

## Compatible Accessories

---



### CB28QU

Single HPL chopping board for minimum radius, oak, measures 280 x 418 H 12 mm



### KITDSQ

Soap dispenser chrome finishing with square knob 40x40 mm



### KITFD075

Waste disposal 0,75 HP, Motor: 1/2 horsepower, Fits all sinks with 3 1/2" waste outlet



### COL36

St/steel colander for MINIMUM radius bowls, measures 370 x 410 x 30 mm



### KITFD050

Waste disposal 0,5 HP, Motor: 1/2 horsepower, Fits all sinks with 3 1/2" waste outlet













### KITFD100

Waste disposal 1 HP, Motor: 1/2 horsepower, Fits all sinks with 3 1/2" waste outlet

---

## Symbols glossary

---

	Antibacterial		Antiscratch
	Cupboard width required for sink installation.		Sink depth - depending on the model, the depth can be from 13 to 24,5.
	Standard installation: Traditional installation in tabletop, suitable for any kitchen sets.		Thermal shock resistant
	High temperatures resistant		Impact resistant
	Easy to clean		UV protection, does not fade over time.