

VZ3434N

Sink material	Composite
Type	Synthetic sink
No. of bowls	2
Drainer	No
EAN code	8017709213565



Aesthetics



Aesthetic	Universal	Logo	Applied/on overflow
Serie	Quadra	Alternative colours available	White, Cream, Beige, Cemento / Concrete, EXTRA White, EXTRA Black
Colour	Black	Half bowl cup drainer	No
Building in type	Standard	Tap hole / precut tap hole	Prepared

	Bowl type RH	Bowl dimensions, WxDxH (mm)	Bowl depth (mm)	Radius corner right bowl (mm)	Overflow	Strainer position	Strainer dimension
RH Bowl	Minimum radius	343 x 395 x 220	220	5	No	Wall position	3.5"
LH Bowl	Minimum radius	343 x 395 x 220	220	5	Yes, traditional	Side bowl	3.5"

Technical Features



Características do material composto

Válvula de escoamento, Fácil de limpar, Sifão com ligação à máquina de lavar louça, Resistente a choques térmicos, Ganchos de fixação, Vedantes, Resistente a UV

Tap hole	1
Diâmetro do furo da torneira	35 mm
Popup command	No
Dividing wall width	34 mm

Frame depth (mm)	10	Pre-assembled gasket	No
Dimensions of the product (mm)	235x790x500 mm	No. of clips	4
Cutout dimension topmount (mm)	770 X 480 mm	Type of clips	Standard
Cutout radius	10 mm		
Height from kitchen top	10 mm		
Base unit size	80 cm		

Accessories Included

Accessories for installation	Strainer, Siphon with dishwasher outlet connection, Fixing clips	Basket	No
Colander	No	Wooden board	No
Rondò Cover waste kit	No	White board	No
Glass board	No		

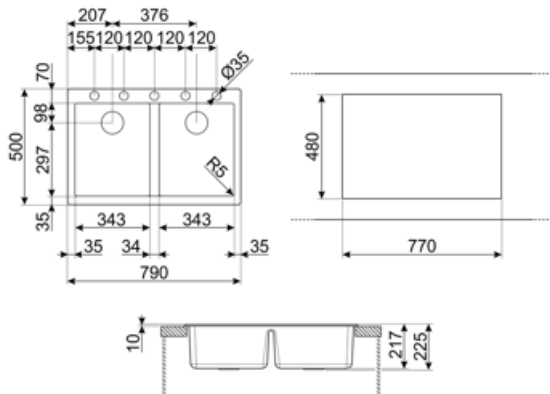

Compatible Accessories



CB28QU

Tábua única de corte HPL para raio mínimo, carvalho, mede 280 x 418 H 12 mm



KITDSQ

Botão quadrado do dispensador de sabão



KITFD075

Eliminação de resíduos 0,75 CV Motor: 3/4 CV Adapta-se a todas as pias com saída de resíduos de 3 1/2"



COL36

Coador de aço para tigelas de raio mínimo, mede 370 x 410 x 30 mm



KITFD050











Eliminação de resíduos 0,5 CV Motor: 1/2 cv Serve para todas as pias com saída de resíduos de 3 1/2"



KITFD100

Eliminação de resíduos 1 CV Motor: 1 cv Serve para todas as pias com saída de resíduos de 3 1/2"

Symbols glossary

	Antisséptico		Antirrisco
	Largura do armário necessária para a instalação da pia		Profundidade da pia - dependendo do modelo, a profundidade pode ser de 13 a 24,5
	Instalação padrão: Instalação tradicional em tampo de mesa, adequado para qualquer conjunto de cozinha		Fácil de limpar
	Resistente a choques térmicos		Resistente a altas temperaturas
	Resistente a impactos		A proteção UV, não se desvanece com o tempo.

Benefit (TT)

Two bowls

Two bowls for greater versatility and dual functionality

Tap hole possibility

Possibility of having the tap hole for direct installation of the tap on the sink, for a larger and neater surface area