

VZ40B

Sink material Composite
 Type Synthetic bowl
 No. of bowls 1
 EAN code 8017709183295

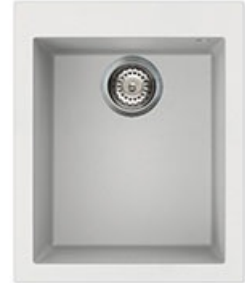

Aesthetics



Aesthetic	Universal	Logo	On overflow
Serie	Quadra	Alternative colours available	Black, Cream, Beige, Cemento / Concrete, EXTRA White, EXTRA Black
Colour	White	Half bowl cup drainer	No
Building in type	Standard	Tap hole / precut tap hole	Prepared

	Bowl type	Bowl dimensions, WxDxH (mm)	Bowl depth (mm)	Radius corner bowl	Overflow	Strainer position	Strainer dimension
Bowl	Minimum radius	340 x 400 x 210	210	5	Yes, traditional	Wall position	3.5"

Technical Features



Características do material composto

Válvula de escoamento, Fácil de limpar, Sifão com ligação à máquina de lavar louça, Resistente a choques térmicos, Ganchos de fixação, Vedantes, Resistente a UV

Dimensions of the product (mm)

210x410x500 mm

Diâmetro do furo da torneira 35 mm

Popup command No

Pre-assembled gasket No

No. of clips 4

Type of clips Standard

Cutout dimension topmount (mm)	390 X 480 mm
Height from kitchen top	10 mm
Base unit size	45 cm
Tap hole	1

Accessories Included

Accessories for installation	Strainer, Siphon with dishwasher outlet connection, Fixing clips	Basket	No
		Wooden board	No
		White board	No
Colander	No		
Rondò Cover waste kit	No		
Glass board	No		

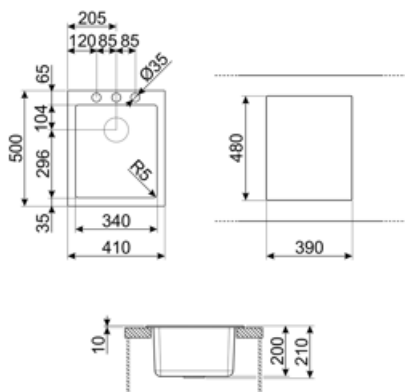

Compatible Accessories



CB28QU

Tábua única de corte HPL para raio mínimo, carvalho, mede 280 x 418 H 12 mm



KITDSQ

Botão quadrado do dispensador de sabão



KITFD075

Eliminação de resíduos 0,75 CV Motor: 3/4 CV Adapta-se a todas as pias com saída de resíduos de 3 1/2"



KITPOPUP2

1 kit automático de resíduos com botão quadrado para pias compostas UNIVERSAL



KITDS

Botão redondo dispensador de sabão



KITFD050











Eliminação de resíduos 0,5 CV Motor: 1/2 cv Serve para todas as pias com saída de resíduos de 3 1/2"



KITFD100

Eliminação de resíduos 1 CV Motor: 1 cv Serve para todas as pias com saída de resíduos de 3 1/2"

Symbols glossary

	Largura do armário necessária para a instalação da pia		Profundidade da pia - dependendo do modelo, a profundidade pode ser de 13 a 24,5
	Instalação padrão: Instalação tradicional em tampo de mesa, adequado para qualquer conjunto de cozinha		Antisséptico
	Antirrisco		Resistente a choques térmicos
	Resistente a altas temperaturas		Resistente a impactos
	Fácil de limpar		A proteção UV, não se desvanece com o tempo.

Benefit (TT)

One bowl

A single bowl for greater adaptability, capacity and space optimisation

Tap hole possibility

Possibility of having the tap hole for direct installation of the tap on the sink, for a larger and neater surface area