

VZ40CT

Sink material	Composite
Type	Synthetic bowl
No. of bowls	1
EAN code	8017709251826



Aesthetics



Aesthetic	Universal	Logo	On overflow
Serie	Quadra	Alternative colours available	Black, White, Cream, Beige, EXTRA White, EXTRA Black
Colour	Cement / Concrete	Half bowl cup drainer	No
Building in type	Standard	Tap hole / precut tap hole	Prepared

	Bowl type	Bowl dimensions, WxDxH (mm)	Bowl depth (mm)	Radius corner bowl	Overflow	Strainer position	Strainer dimension
Bowl	Minimum radius	340 x 400 x 210	210	5	Yes, traditional	Wall position	3.5"

Technical Features



Características do material composto	Válvula de escoamento, Fácil de limpar, Sifão com ligação à máquina de lavar louça, Resistente a choques térmicos, Ganchos de fixação, Vedantes, Resistente a UV	Diâmetro do furo da torneira	35 mm
Dimensions of the product (mm)	210x410x500 mm	Popup command	No
Cutout dimension topmount (mm)	390 X 480 mm	Pre-assembled gasket	No
		No. of clips	4
		Type of clips	Standard

Height from kitchen top 10 mm
Base unit size 45 cm
Tap hole 1

Accessories Included

Accessories for installation	Strainer, Siphon with dishwasher outlet connection, Fixing clips	Basket	No
Colander	No	Wooden board	No
Rondò Cover waste kit	No	White board	No
Glass board	No		

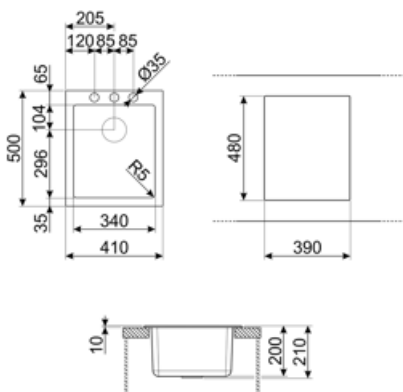

Compatible Accessories



CB28QU

Tábua única de corte HPL para raio mínimo, carvalho, mede 280 x 418 H 12 mm



KITDS

Botão redondo dispensador de sabão



KITDSQ

Botão quadrado do dispensador de sabão



KITFD050

Eliminação de resíduos 0,5 CV Motor: 1/2 cv Serve para todas as pias com saída de resíduos de 3 1/2"



KITFD075

Eliminação de resíduos 0,75 CV Motor: 3/4 CV Adapta-se a todas as pias com saída de resíduos de 3 1/2"



KITFD100











Eliminação de resíduos 1 CV Motor: 1 cv Serve para todas as pias com saída de resíduos de 3 1/2"



KITPOPUP2

1 kit automático de resíduos com botão quadrado para pias compostas UNIVERSAL

Symbols glossary

	Antisséptico		Antirrisco
	Largura do armário necessária para a instalação da pia		Profundidade da pia - dependendo do modelo, a profundidade pode ser de 13 a 24,5
	Instalação padrão: Instalação tradicional em tampo de mesa, adequado para qualquer conjunto de cozinha		Fácil de limpar
	Resistente a choques térmicos		Resistente a altas temperaturas
	Resistente a impactos		A proteção UV, não se desvanece com o tempo.

Benefit (TT)

One bowl

A single bowl for greater adaptability, capacity and space optimisation

Tap hole possibility

Possibility of having the tap hole for direct installation of the tap on the sink, for a larger and neater surface area