

VZ57B

Sink material Composite
Type Composite bowl
No. of bowls 1
EAN code 8017709183356



Aesthetics



Aesthetic	Universale	Logo	On overflow
Series	Quadra	Alternative colours available	Black, Cream, Beige, Cemento / Concrete, EXTRA White, EXTRA Black
Colour	White	Tap hole / precut tap hole	Prepared
Building in type	Standard		

	Bowl type	Bowl dimensions, WxDxH (mm)	Bowl depth (mm)	Radius corner bowl	Overflow	Strainer position	Strainer dimension
Bowl	Minimum radius	500 x 400 x 210	210	5	Yes, traditional	Wall position	3.5"

Technical Features



Characteristics composite material	Antibacterial, Easy to clean, Anti-scratch, Thermal shock resistant, High temperatures resistant, Impact resistant, UV Resistant	Tap hole	1
		Tap hole diameter	35 mm
		No. of clips	8
		Type of clips	Standard
Dimensions of the product (mm)	210x570x500 mm		
Cutout dimension topmount (mm)	550 X 480 mm		

Height from kitchen top 10 mm
Base unit size 60 cm

Accessories Included

Accessories for
installation

Strainer, Savespace siphon
with dishwasher outlet
connection, Fixing clips

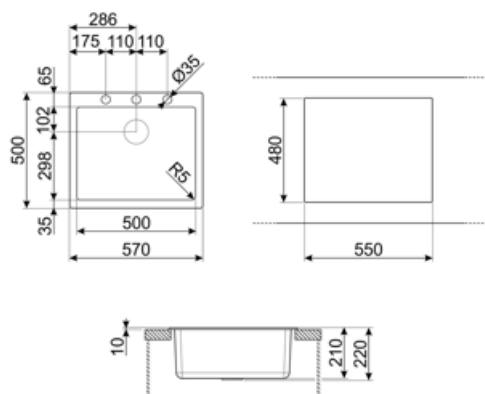

Compatible Accessories



CB25MN

Single HPE chopping board to fit minimum radius bowls, black matt, measures 250 x 410 H 12 mm, dishwasher safe



COL19

St/Steel colander to fit MINIMUM radius mm bowl, measures 200 x 410 x 26 mm



COL36

St/steel colander for MINIMUM radius bowls, measures 370 x 410 x 30 mm



KITFD050

Waste disposal 0,5 HP, Motor: 1/2 horsepower, Fits all sinks with 3 1/2" waste outlet



KITFD100

Waste disposal 1 HP, Motor: 1/2 horsepower, Fits all sinks with 3 1/2" waste outlet



CB28QU

Single HPL chopping board for minimum radius, oak, measures 280 x 418 H 12 mm



COL19H

St/Steel colander to fit MINIMUM radius mm bowl, measures 200 x 410 x 100 mm



KITDSQ











Soap dispenser chrome finishing with square knob 40x40 mm



KITFD075

Waste disposal 0,75 HP, Motor: 1/2 horsepower, Fits all sinks with 3 1/2" waste outlet

Symbols glossary

	Cupboard width required for sink installation		Sink depth - depending on the model, the depth can be from 13 to 24,5
	Standard installation: Traditional installation in tabletop, suitable for any kitchen sets		Antibacterial
	Antiscratch		Thermal shock resistant
	High temperatures resistant		Impact resistant
	Easy to clean		UV protection, does not fade over time.

Benefit (TT)

One bowl

A single bowl for greater adaptability, capacity and space optimisation

Tap hole possibility

Possibility of having the tap hole for direct installation of the tap on the sink, for a larger and neater surface area