

VZ57B

Sink material Composite
 Type Synthetic bowl
 No. of bowls 1
 EAN code 8017709183356



Aesthetics



| | | | |
|-------------------------|-----------|--------------------------------------|---|
| Aesthetic | Universal | Logo | On overflow |
| Serie | Quadra | Alternative colours available | Black, Cream, Beige, Cemento / Concrete, EXTRA White, EXTRA Black |
| Colour | White | Half bowl cup drainer | No |
| Building in type | Standard | Tap hole / precut tap hole | Prepared |

| | Bowl type | Bowl dimensions, WxDxH (mm) | Bowl depth (mm) | Radius corner bowl | Overflow | Strainer position | Strainer dimension |
|------|----------------|-----------------------------|-----------------|--------------------|------------------|-------------------|--------------------|
| Bowl | Minimum radius | 500 x 400 x 210 | 210 | 5 | Yes, traditional | Wall position | 3.5" |

Technical Features



Características do material composto

Válvula de escoamento, Fácil de limpar, Sifão com ligação à máquina de lavar louça, Resistente a choques térmicos, Ganchos de fixação, Vedantes, Resistente a UV

Dimensions of the product (mm)

210x570x500 mm

Diâmetro do furo da torneira 35 mm

Popup command No

Pre-assembled gasket No

No. of clips 8

Type of clips Standard

| | |
|-----------------------------------|--------------|
| Cutout dimension topmount (mm) | 550 X 480 mm |
| Height from kitchen top | 10 mm |
| Base unit size | 60 cm |
| Tap hole | 1 |

Accessories Included

| | | | |
|---------------------------------|--|---------------------|----|
| Accessories for installation | Strainer, Siphon with dishwasher outlet connection, Fixing clips | Basket | No |
| Colander | No | Wooden board | No |
| Rondò Cover waste kit | No | White board | No |
| Glass board | No | | |

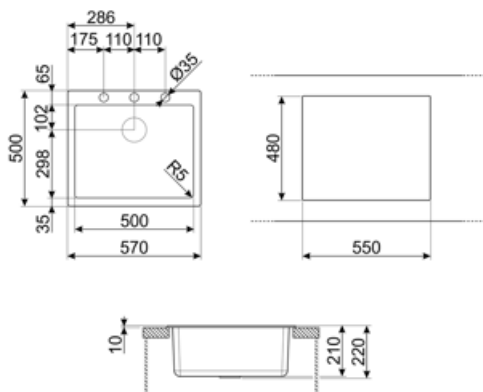

Compatible Accessories



CB25MN

Tábua única de corte HPE para caber em tigelas de raio mínimo, fosca preta, mede 250 x 410 H 12 mm, pode ir à máquina lava-louça



COL19

Coador aço inox para encaixar na tigela de raio MÍNIMO mm, mede 200 x 410 x 26 mm



COL36

Coador de aço para tigelas de raio mínimo, mede 370 x 410 x 30 mm



KITFD050

Eliminação de resíduos 0,5 CV Motor: 1/2 cv Serve para todas as pias com saída de resíduos de 3 1/2"



KITFD100

Eliminação de resíduos 1 CV Motor: 1 cv Serve para todas as pias com saída de resíduos de 3 1/2"



CB28QU

Tábua única de corte HPL para raio mínimo, carvalho, mede 280 x 418 H 12 mm



COL19H

Coador aço inox para encaixar na tigela de raio MÍNIMO mm, mede 200 x 410 x 100 mm



KITDSQ











Botão quadrado do dispensador de sabão



KITFD075

Eliminação de resíduos 0,75 CV Motor: 3/4 CV Adapta-se a todas as pias com saída de resíduos de 3 1/2"

Symbols glossary

| | | | |
|--|--|---|--|
|  | Antisséptico |  | Antirrisco |
|  | Largura do armário necessária para a instalação da pia |  | Profundidade da pia - dependendo do modelo, a profundidade pode ser de 13 a 24,5 |
|  | Instalação padrão: Instalação tradicional em tampo de mesa, adequado para qualquer conjunto de cozinha |  | Fácil de limpar |
|  | Resistente a choques térmicos |  | Resistente a altas temperaturas |
|  | Resistente a impactos |  | A proteção UV, não se desvanece com o tempo. |

Benefit (TT)

One bowl

A single bowl for greater adaptability, capacity and space optimisation

Tap hole possibility

Possibility of having the tap hole for direct installation of the tap on the sink, for a larger and neater surface area