

Serienzubehör

Serien-Montagezubehör Ab- und Überlaufgarnitur,
Siphon mit
Schlauchanschluss,
Befestigungshaken

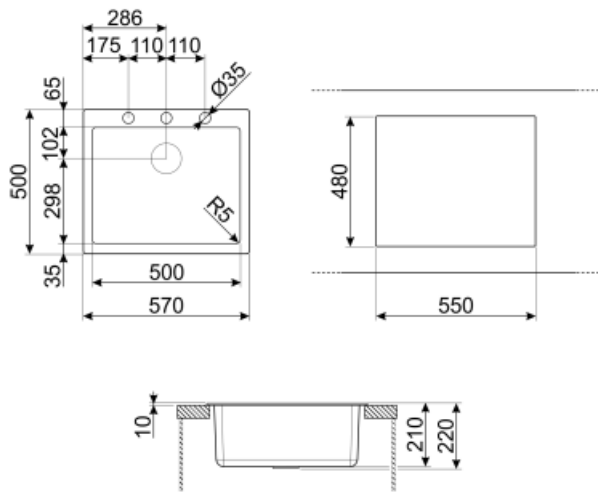

Sonderzubehör



KITFD050

Waste disposal 0,5 HP, Motor: 1/2 horsepower, Fits all sinks with 3 1/2" waste outlet

KITFD100

Zerkleinerer von Küchenabfällen für Spülbecken mit 3 1/2" Korbventil.
TECHNISCHE DATEN: Leistung: 1,0 PS, 2800 U/min, max. Leistungsaufnahme 550 W, Spannung/Frequenz 220-240V/50Hz~1N, Gewicht netto 4,7 kg
Hinweis: Zerkleinerer von weichen organischen Küchen



COL36

Abtropfbecken gelocht aus Edelstahl mit Kunststoffecken, kompatibel für Becken mit Minimalradius. Abmessungen LxBxH: 418x280x12 mm



COL19H

Abtropfbecken gelocht aus Edelstahl mit Kunststoffecken, kompatibel für Becken mit Minimalradius. Abmessungen LxBxH: 410x200x100 mm



COL19

Abtropfbecken gelocht aus Edelstahl mit Kunststoffecken, kompatibel für Becken mit Minimalradius. Abmessungen LxBxH: 410x200x26 mm

CB25MN

HPE-Schneidebrett in Schwarz-Matt, spülmaschineneignet, kompatibel für Becken mit Minimalradius. Abmessungen LxBxH: 410x250x12 mm



CB28QU

HPE-Schneidebrett in Oak, kompatibel für Becken mit Minimalradius. Abmessungen LxBxH: 418 x 280 x 12 mm.



KITDSQ











Einbau-Seifenspender, Chrom, eckige Bauform, Hahnlochbohrung Ø 35 mm (Montage in Armaturenbank oder Arbeitsplatte)



KITFD075

Waste disposal 0,75 HP, Motor: 1/2 horsepower, Fits all sinks with 3 1/2" waste outlet

Symbols glossary (TT)

	Antibakteriell		Antiscratch
	Cupboard width required for sink installation		Sink depth - depending on the model, the depth can be from 13 to 24,5
	Standardeinbau: Klassische aufgesetzte Montage auf der Arbeitsplatte.		Thermal shock resistant
	High temperatures resistant		Impact resistant
	Easy to clean		UV protection, does not fade over time.