

# VZ57N

**Sink material** Composite  
**Type** Composite bowl  
**No. of bowls** 1  
**EAN code** 8017709183363



## Aesthetics



**Aesthetic** Universale  
**Colour** Black  
**Series** Quadra  
**Building in type** Standard  
**Logo** On overflow  
**Alternative colours available** White, Cream, Beige, Cemento / Concrete, EXTRA White, EXTRA Black  
**Tap hole / precut tap hole** Prepared

	Bowl type	Bowl dimensions, WxDxH (mm)	Bowl depth (mm)	Radius corner bowl	Overflow	Strainer position	Strainer dimension
Bowl	Minimum radius	500 x 400 x 210	210	5	Yes, traditional	Wall position	3.5"

## Technical Features



**Characteristics composite material** Antibacterial, Easy to clean, Anti-scratch, Thermal shock resistant, High temperatures resistant, Impact resistant, UV Resistant  
**Dimensions of the product (mm)** 210x570x500 mm  
**Cutout dimension topmount (mm)** 550 X 480 mm  
**Tap hole** 1  
**Tap hole diameter** 35 mm  
**No. of clips** 8  
**Type of clips** Standard  
**Possibility to install waste disposal** Yes

Height from kitchen top 10 mm  
Base unit size 60 cm

## Accessories included

Accessories for installation

Strainer, Savespace siphon with dishwasher outlet connection, Fixing clips

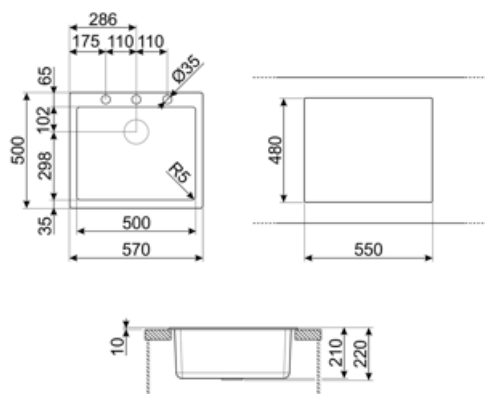

## Compatible Accessories



### CB25MN

Single HPE chopping board to fit minimum radius bowls, black matt, measures 250 x 410 H 12 mm, dishwasher safe



### COL19

St/Steel colander to fit MINIMUM radius mm bowl, measures 200 x 410 x 26 mm



### COL36

St/steel colander for MINIMUM radius bowls, measures 370 x 410 x 30 mm



### KITFD050

Waste disposal 0,5 HP, Motor: 1/2 horsepower, Fits all sinks with 3 1/2" waste outlet



### KITFD100

Waste disposal 1 HP, Motor: 1/2 horsepower, Fits all sinks with 3 1/2" waste outlet



### CB28QU

Single HPL chopping board for minimum radius, oak, measures 280 x 418 H 12 mm



### COL19H

St/Steel colander to fit MINIMUM radius mm bowl, measures 200 x 410 x 100 mm



### KITDSQ

Soap dispenser chrome finishing with square knob 40x40 mm



### KITFD075

Waste disposal 0,75 HP, Motor: 1/2 horsepower, Fits all sinks with 3 1/2" waste outlet

---

## Alternative products

---



**VZ57CT**

**Colour:** Cement / Concrete

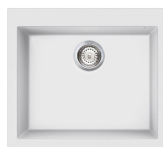











**VZ57B**

**Colour:** White

---

## Symbols glossary

---

	Cupboard width required for sink installation.		Sink depth - depending on the model, the depth can be from 13 to 24,5.
	Standard installation: Traditional installation in tabletop, suitable for any kitchen sets.		Antibacterial
	Antiscratch		Thermal shock resistant
	High temperatures resistant		Impact resistant
	Easy to clean		UV protection, does not fade over time.

---

## Benefit (TT)

---

### **One bowl**

A single bowl for greater adaptability, capacity and space optimisation

### **Tap hole possibility**

Possibility of having the tap hole for direct installation of the tap on the sink, for a larger and neater surface area

### **Waste Kit**

Possibility to install the waste disposal KITFD100 to easily dispose of organic waste, saving time and effort

The waste disposal is the ideal solution for a clean and sustainable kitchen: simple to use and compact, it disposes of food waste directly from the sink, reducing kitchen bad smells and improving hygiene.