

# VZ57N

Material del fregadero Granito  
 Tipología Cubeta de composite  
 Número de cubetas 1  
 Código EAN 8017709183363



## Estética



Estética Universal  
 Color Negro  
 Serie Quadra  
 Tipo de instalación Estándar

Logo En el rebosadero  
 Otros colores disponibles Blanco, Crema, Avena, Cemento / Hormigón, EXTRA Blanco, EXTRA Negro  
 Agujero para grifo / Agujero para grifo precortado Preparado

	Tipología cubeta	Dimensiones cubeta , L x P x A (mm)	Profundidad cubeta (mm)	Radio angular cubeta	Rebosadero	Posición filtro	Dimensión filtro
Cubeta	Rayada	500 x 400 x 210	210	5	Sí, tradicional	De pared	3.5"

## Características técnicas



Characteristics composite material

Cubeta, Fácil de limpiar, Sifón con conexión para lavavajillas, Resistente al choque térmico, Ganchos montaje, Junta, Resistente a los rayos UV

Dimensiones del producto (mm)

210x570x500 mm

Orificio mezclador 1  
 Diámetro del orificio del grifo 35 mm  
 Número de ganchos 8  
 Tipología ganchos Estándar  
 Possibility to install waste disposal Sí

---

Dimensiones hueco instalación sobre encimera (mm)	550 X 480 mm
Altura desde encimera de la cocina	10 mm
Medida mueble empotrable	60 cm

## Equipo accesorios incluidos

---

Equipo accesorios montaje	Cubeta, Sifón con conexión para lavavajillas, Ganchos montaje
------------------------------	---

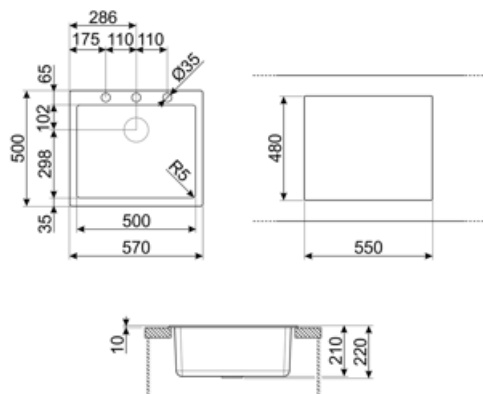

## Accesorios Compatible



### CB25MN

Single HPE chopping board to fit minimum radius bowls, black matt, measures 250 x 410 H 12 mm, dishwasher safe



### COL19

St/Steel colander to fit MINIMUM radius mm bowl, measures 200 x 410 x 26 mm



### COL36

St/steel colander for MINIMUM radius bowls, measures 370 x 410 x 30 mm



### KITFD050

Triturador de residuos 0,5 HP, Motor: 1/2 caballo de potencia, Se adapta a todos los fregaderos con salida de residuos de 3 1/2



### KITFD100

Triturador de residuos 1 HP, Motor: 1/2 caballo de potencia, compatible con todos los fregaderos con salida de desagüe de 3 1/2".



### CB28QU

Single HPL chopping board for minimum radius, oak, measures 280 x 418 H 12 mm



### COL19H

St/Steel colander to fit MINIMUM radius mm bowl, measures 200 x 410 x 100 mm



### KITDSQ

Soap dispenser chrome finishing with square knob 40x40 mm



### KITFD075

Triturador de residuos 0,75 HP, Motor: 1/2 caballo de potencia, compatible con todos los fregaderos con salida de desagüe de 3 1/2".

---

## Productos alternativos

---



**VZ57CT**

**Color: Cemento**













**VZ57B**

**Color: Blanco**

---

## Symbols glossary

---

	Antibacterial		Antiscratch
	Tamaño del mueble base: Se requiere el tamaño del gabinete base para la instalación del fregadero.		Indica la profundidad de la cubeta del fregadero
	Estándar: método de instalación, que se adapta fácilmente a cualquier tipo de cocina.		Fácil de limpiar
	High temperatures resistant		Impact resistant
	Resistente al choque térmico		UV protection, does not fade over time.

## Benefit (TT)

---

**Un solo seno para una mayor adaptabilidad, capacidad y optimización del espacio.**

Un solo seno para una mayor adaptabilidad, capacidad y optimización del espacio.

### **Posibilidad de orificio para grifo**

Posibilidad de incluir el orificio para la instalación directa del grifo sobre el fregadero, lo que permite una superficie más amplia y despejada.

### **Kit para la eliminación de residuos**

Posibilidad de instalar el KITFD100 para desechar fácilmente los residuos orgánicos, ahorrando tiempo y esfuerzo.

La eliminación de residuos es la solución ideal para una cocina limpia y sostenible: fácil de usar y compacto, elimina los restos de comida directamente desde el fregadero, reduciendo los malos olores y mejorando la higiene.