

VZ57N

Sink material	Composite
Type	Synthetic bowl
No. of bowls	1
EAN code	8017709183363



Aesthetics



Aesthetic	Universal	Logo	On overflow
Serie	Quadra	Alternative colours available	White, Cream, Beige, Cemento / Concrete, EXTRA White, EXTRA Black
Colour	Black	Half bowl cup drainer	No
Building in type	Standard	Tap hole / precut tap hole	Prepared

	Bowl type	Bowl dimensions, WxDxH (mm)	Bowl depth (mm)	Radius corner bowl	Overflow	Strainer position	Strainer dimension
Bowl	Minimum radius	500 x 400 x 210	210	5	Yes, traditional	Wall position	3.5"

Technical Features



Características do material composto

Válvula de escoamento, Fácil de limpar, Sifão com ligação à máquina de lavar louça, Resistente a choques térmicos, Ganchos de fixação, Vedantes, Resistente a UV

Dimensions of the product (mm)

210x570x500 mm

Diâmetro do furo da torneira 35 mm

Popup command No

Pre-assembled gasket No

No. of clips 8

Type of clips Standard

Cutout dimension topmount (mm)	550 X 480 mm
Height from kitchen top	10 mm
Base unit size	60 cm
Tap hole	1

Accessories Included

Accessories for installation	Strainer, Siphon with dishwasher outlet connection, Fixing clips	Basket	No
Colander	No	Wooden board	No
Rondò Cover waste kit	No	White board	No
Glass board	No		

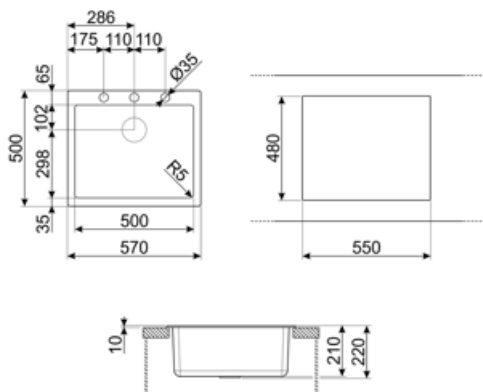

Compatible Accessories



CB25MN

Tábua única de corte HPE para caber em tigelas de raio mínimo, fosca preta, mede 250 x 410 H 12 mm, pode ir à máquina lava-louça



COL19

Coador aço inox para encaixar na tigela de raio MÍNIMO mm, mede 200 x 410 x 26 mm



COL36

Coador de aço para tigelas de raio mínimo, mede 370 x 410 x 30 mm



KITFD050

Eliminação de resíduos 0,5 CV Motor: 1/2 cv Serve para todas as pias com saída de resíduos de 3 1/2"



KITFD100

Eliminação de resíduos 1 CV Motor: 1 cv Serve para todas as pias com saída de resíduos de 3 1/2"



CB28QU

Tábua única de corte HPL para raio mínimo, carvalho, mede 280 x 418 H 12 mm



COL19H

Coador aço inox para encaixar na tigela de raio MÍNIMO mm, mede 200 x 410 x 100 mm



KITDSQ











Botão quadrado do dispensador de sabão



KITFD075

Eliminação de resíduos 0,75 CV Motor: 3/4 CV Adapta-se a todas as pias com saída de resíduos de 3 1/2"

Symbols glossary

	Antisséptico		Antirrisco
	Largura do armário necessária para a instalação da pia		Profundidade da pia - dependendo do modelo, a profundidade pode ser de 13 a 24,5
	Instalação padrão: Instalação tradicional em tampo de mesa, adequado para qualquer conjunto de cozinha		Fácil de limpar
	Resistente a choques térmicos		Resistente a altas temperaturas
	Resistente a impactos		A proteção UV, não se desvanece com o tempo.

Benefit (TT)

One bowl

A single bowl for greater adaptability, capacity and space optimisation

Tap hole possibility

Possibility of having the tap hole for direct installation of the tap on the sink, for a larger and neater surface area