

VZ79B

Sink material Composite
 Type Composite bowl
 No. of bowls 1
 EAN code 8017709183417



Aesthetics



Aesthetic Universale
Colour White
Series Quadra
Building in type Standard

Logo On overflow
Alternative colours available Black, Cream, Beige, Cemento / Concrete, EXTRA White, EXTRA Black
Tap hole / precut tap hole Prepared

	Bowl type	Bowl dimensions, WxDxH (mm)	Bowl depth (mm)	Radius corner bowl	Overflow	Strainer position	Strainer dimension
Bowl	Minimum radius	720 x 400 x 210	210	5	Yes, traditional	Wall position	3.5"

Technical Features



Characteristics composite material Antibacterial, Easy to clean, Anti-scratch, Thermal shock resistant, High temperatures resistant, Impact resistant, UV Resistant

Dimensions of the product (mm) 210x790x500 mm

Cutout dimension topmount (mm) 770 X 480 mm

Tap hole 1
Tap hole diameter 35 mm
No. of clips 10
Type of clips Standard
Possibility to install waste disposal Yes

Height from kitchen top 10 mm
Base unit size 80 cm

Accessories included

Accessories for installation Strainer, Savespace siphon with dishwasher outlet connection, Fixing clips

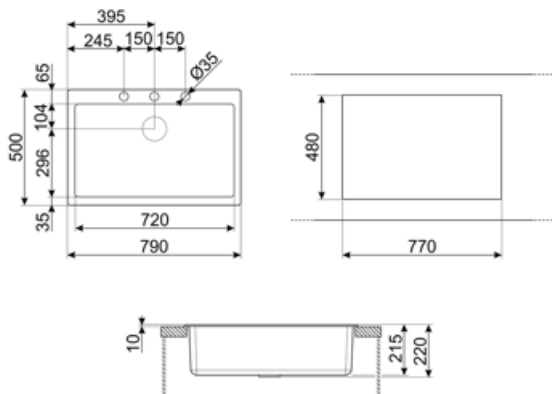

Compatible Accessories



CB25MN

Single HPE chopping board to fit minimum radius bowls, black matt, measures 250 x 410 H 12 mm, dishwasher safe



COL19

St/Steel colander to fit MINIMUM radius mm bowl, measures 200 x 410 x 26 mm



COL36

St/steel colander for MINIMUM radius bowls, measures 370 x 410 x 30 mm



KITFD050

Waste disposal 0,5 HP, Motor: 1/2 horsepower, Fits all sinks with 3 1/2" waste outlet



KITFD100

Waste disposal 1 HP, Motor: 1/2 horsepower, Fits all sinks with 3 1/2" waste outlet



CB28QU

Single HPL chopping board for minimum radius, oak, measures 280 x 418 H 12 mm



COL19H

St/Steel colander to fit MINIMUM radius mm bowl, measures 200 x 410 x 100 mm



KITDSQ

Soap dispenser chrome finishing with square knob 40x40 mm



KITFD075

Waste disposal 0,75 HP, Motor: 1/2 horsepower, Fits all sinks with 3 1/2" waste outlet

Alternative products

VZ79CT

Colour: Cement / Concrete













VZ79N

Colour: Black



Symbols glossary

	Antibacterial		Antiscratch
	Cupboard width required for sink installation.		Sink depth - depending on the model, the depth can be from 13 to 24,5.
	Standard installation: Traditional installation in tabletop, suitable for any kitchen sets.		Thermal shock resistant
	High temperatures resistant		Impact resistant
	Easy to clean		UV protection, does not fade over time.

Benefit (TT)

One bowl

A single bowl for greater adaptability, capacity and space optimisation

Tap hole possibility

Possibility of having the tap hole for direct installation of the tap on the sink, for a larger and neater surface area

Waste Kit

Possibility to install the waste disposal KITFD100 to easily dispose of organic waste, saving time and effort

The waste disposal is the ideal solution for a clean and sustainable kitchen: simple to use and compact, it disposes of food waste directly from the sink, reducing kitchen bad smells and improving hygiene.