

VZP45DV

Sink material Composite
 Type Composite bowl
 No. of bowls 1
 EAN code 8017709294144



Aesthetics



Serie Quadra
 Aesthetic Universale
 Color Dove Gray
 Building in type Standard, Undermount
 Logo On overflow
 Alternative colours available Black, White, Cemento / Concrete
 Tap hole / precut tap hole No Taphole

	Bowl type	Bowl dimensions, WxDxH (mm)	Bowl depth (mm)	Radius corner bowl	Overflow	Strainer position	Strainer dimension
Bowl	Minimum radius	400 x 400 x 215	215	10	Yes, flush fitted	Wall position	3.5"

Technical Features



Characteristics composite material Antibacterial, Anti-scratch, Termal schock resistant, High temperatures resistant, Impact resistant, Easy to clean, UV Resistant
 Dimensions of the product (mm) 215x456x456 mm
 Cutout dimension topmount (mm) 446x446 mm
 Cutout dimension undermount (mm) 400x400 mm
 Height from kitchen top 6 mm
 Base unit size 45, 50 cm
 No. of clips 4
 Type of clips Standard + undermount clip

Undermount cutout radius 10 mm

Accessories Included

Accessories for installation: Strainer, Savespace siphon with dishwasher outlet connection, Fixing clips

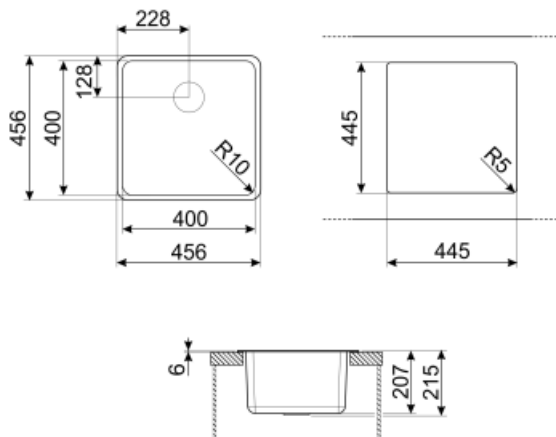

Not included accessories



KITFD050

Waste disposal 0,5 HP, Motor: 1/2 horsepower, Fits all sinks with 3 1/2" waste outlet



KITFD100

Waste disposal 1 HP, Motor: 1/2 horsepower, Fits all sinks with 3 1/2" waste outlet



COL19

St/Steel colander to fit MINIMUM radius mm bowl, measures 200 x 410 x 26 mm



CB25MN

Single HPE chopping board to fit minimum radius bowls, black matt, measures 250 x 410 H 12 mm, dishwasher safe



KITFD050UK

Waste disposal 0,5 HP, Motor: 1/2 horsepower, Fits all sinks with 3 1/2" waste outlet, UK

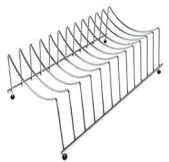

COLPTX

Draining rack base 300 x 185 x 82 mm



COL36

St/steel colander for MINIMUM radius bowls, measures 370 x 410 x 30 mm



COL19H

St/Steel colander to fit MINIMUM radius mm bowl, measures 200 x 410 x 100 mm



KITDSQ

Soap dispenser chrome finishing with square knob 40x40 mm



KITFD075

Waste disposal 0,75 HP, Motor: 1/2 horsepower, Fits all sinks with 3 1/2" waste outlet



DBSINT34













St/steel drain basket to fit STD radius composite sinks 340 x 400 mm bowl, 180 mm depth



CB28QU

Single HPL chopping board for minimum radius, oak, measures 280 x 418 H 12 mm

Symbols glossary (TT)

	Antibacterial		Antiscratch
	Cupboard width required for sink installation		Cupboard width required for sink installation
	Sink depth - depending on the model, the depth can be from 13 to 24,5		Standard installation: Traditional installation in tabletop, suitable for any kitchen sets
	Under table top installation: The sink is fixed under tabletop, which extends the work surface and the depth of the sink.		Easy to clean
	High temperatures resistant		Impact resistant
	Thermal shock resistant		UV protection, does not fade over time.